

# DATA SHEET

## TRANSIENT VOLTAGE SUPPRESSORS

### AC/DC POWER SUPPLY

1.5SMBJ series

RoHS compliant & Halogen free



Product specification— June 30, 2023 V.1



## Transient Voltage Suppressors (TVS) Data Sheet

### Features

- For surface mounted applications in order to optimize board space
- Low profile package
- Built-in strain relief
- Glass passivated junction
- Low inductance
- Excellent clamping capability
- 1500W peak pulse power capability at 10/1000 $\mu$ s waveform, repetition rate (duty cycle): 0.01%
- Fast response time
- Typical  $I_R$  less than 1 $\mu$ A above 10V
- High Temperature soldering: 260 $^{\circ}$ C/10 seconds at terminals
- Plastic package has underwriters laboratory flammability 94V-0
- Meets MSL level 1, per J-STD-020
- Safety certification: UL
- IEC61000-4-2 ESD 30KV Air, 30KV contact compliance



### Mechanical Data

- Case: JEDEC DO-214AA. Molded plastic over glass passivated junction
- Terminal: Tin plated, solderable per MIL-STD-750, Method 2026
- Polarity: Color band denotes cathode except bi-directional models
- Standard Packaging: 12mm tape (EIA STD RS-481)
- Weight: 0.10g

### Applications

- I/O interface
- AC/DC power supply
- Low frequency signal transmission line (RS232, RS485, etc.)

### Maximum Ratings and Characteristics

Ratings at 25 $^{\circ}$ C ambient temperature unless otherwise specified.

Rating	Symbol	Value	Units
Peak pulse power dissipation at 10/1000 $\mu$ s waveform (Note1, Note2, Fig.1)	$P_{PPM}$	Minimum 1500	Watts
Peak pulse current of at 10/1000 $\mu$ s waveform (Note 1, Fig.3)	$I_{PPM}$	See Table	Amps
Steady state power dissipation at $T_A=50^{\circ}$ C (Fig.5)	$P_{M(AV)}$	5.0	Watts
Peak forward surge current, 8.3ms single half sine-wave superimposed on rated load, (JEDEC Method) (Note3, Fig.6)	$I_{FSM}$	200	Amps
Operating junction and Storage Temperature Range.	$T_J, T_{STG}$	-55 to +150	$^{\circ}$ C
Typical thermal resistance junction to lead	$R_{\theta JL}$	20	$^{\circ}$ C/W
Typical thermal resistance junction to ambient	$R_{\theta JA}$	100	$^{\circ}$ C/W

Notes: 1. Non-repetitive current pulse, per Fig.3 and derated above  $T_A=25^{\circ}$ C per Fig.2.

2. Mounted on 5.0mmx5.0mm copper pads to each terminal.

3. 8.3ms single half sine-wave, or equivalent square wave, duty cycle=4 pulses per minutes maximum.

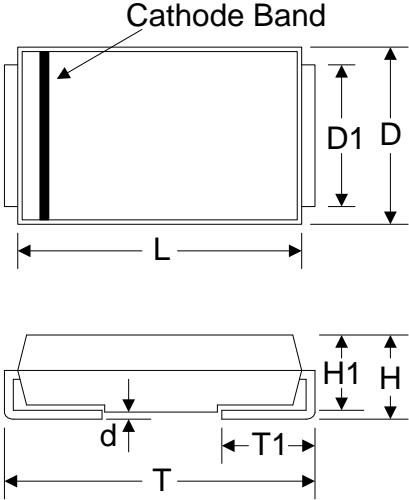
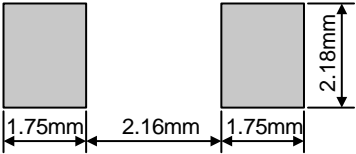

**Dimensions (SMB/DO-214AA)**

Product:		Symbol	Millimeters		Inches	
			Min.	Max.	Min.	Max.
Pad:		L	4.06	4.57	0.160	0.180
		D	3.30	3.94	0.130	0.155
		D1	1.95	2.20	0.077	0.086
		T	5.21	5.59	0.205	0.220
		T1	0.76	1.52	0.030	0.060
		d	-	0.203	-	0.008
		H	2.15	2.65	0.085	0.104
		H1	2.13	2.47	0.084	0.097

**Electrical Characteristics (T<sub>A</sub>=25°C)**

Part Number		Device Marking Code		Reverse Stand-Off Voltage	Breakdown Voltage @I <sub>T</sub>	Test Current	Maximum Clamping Voltage @I <sub>PP</sub>	Peak Pulse Current	Reverse Leakage @V <sub>RWM</sub>
Unidirectional	Bidirectional	UNI	BI	V <sub>RWM</sub> (V)	V <sub>BR</sub> (V)	I <sub>T</sub> (mA)	V <sub>C</sub> (V)	I <sub>PP</sub> (A)	I <sub>R</sub> (μA)
1.5SMBJ5.0A	1.5SMBJ5.0CA	GDE	BDE	5.0	6.40~7.00	10	9.2	163.0	800
1.5SMBJ6.0A	1.5SMBJ6.0CA	GDG	BDG	6.0	6.67~7.37	10	10.3	145.7	800
1.5SMBJ6.5A	1.5SMBJ6.5CA	GDK	BDK	6.5	7.22~7.98	10	11.2	134.0	500
1.5SMBJ7.0A	1.5SMBJ7.0CA	GDM	BDM	7.0	7.78~8.60	10	12.0	125.0	200
1.5SMBJ7.5A	1.5SMBJ7.5CA	GDP	BDP	7.5	8.33~9.21	1	12.9	116.3	100
1.5SMBJ8.0A	1.5SMBJ8.0CA	GDR	BDR	8.0	8.89~9.83	1	13.6	110.3	50
1.5SMBJ8.5A	1.5SMBJ8.5CA	GDT	BDT	8.5	9.44~10.40	1	14.4	104.2	20
1.5SMBJ9.0A	1.5SMBJ9.0CA	GDV	BDV	9.0	10.00~11.10	1	15.4	97.4	10
1.5SMBJ10A	1.5SMBJ10CA	GDY	BDY	10.0	11.10~12.30	1	17.0	88.3	5
1.5SMBJ11A	1.5SMBJ11CA	GDZ	BDZ	11.0	12.20~13.50	1	18.2	82.5	1
1.5SMBJ12A	1.5SMBJ12CA	GEE	BEE	12.0	13.30~14.70	1	19.9	75.4	1
1.5SMBJ13A	1.5SMBJ13CA	GEG	BEG	13.0	14.40~15.90	1	21.5	69.8	1
1.5SMBJ14A	1.5SMBJ14CA	GEK	BEK	14.0	15.60~17.20	1	23.2	64.7	1
1.5SMBJ15A	1.5SMBJ15CA	GEM	BEM	15.0	16.70~18.50	1	24.4	61.5	1
1.5SMBJ16A	1.5SMBJ16CA	GEP	BEP	16.0	17.80~19.70	1	26.0	57.7	1
1.5SMBJ17A	1.5SMBJ17CA	GER	BER	17.0	18.90~20.90	1	27.6	54.4	1
1.5SMBJ18A	1.5SMBJ18CA	GET	BET	18.0	20.00~22.10	1	29.2	51.4	1

## Transient Voltage Suppressors

1.5SMBJ

Part Number		Device Marking Code		Reverse Stand-Off Voltage	Breakdown Voltage @ $I_T$	Test Current	Maximum Clamping Voltage @ $I_{PP}$	Peak Pulse Current	Reverse Leakage @ $V_{RWM}$
Unidirectional	Bidirectional	UNI	BI	$V_{RWM}(V)$	$V_{BR}(V)$	$I_T(mA)$	$V_C(V)$	$I_{PP}(A)$	$I_R(\mu A)$
1.5SMBJ20A	1.5SMBJ20CA	GEV	BEV	20.0	22.20~24.50	1	32.4	46.3	1
1.5SMBJ22A	1.5SMBJ22CA	GEX	BEX	22.0	24.40~26.90	1	35.5	42.3	1
1.5SMBJ24A	1.5SMBJ24CA	GEZ	BEZ	24.0	26.70~29.50	1	38.9	38.6	1
1.5SMBJ26A	1.5SMBJ26CA	GFE	BFE	26.0	28.90~31.90	1	42.1	35.7	1
1.5SMBJ28A	1.5SMBJ28CA	GFG	BFG	28.0	31.10~34.40	1	45.4	33.1	1
1.5SMBJ30A	1.5SMBJ30CA	GFK	BFK	30.0	33.30~36.80	1	48.4	31.0	1
1.5SMBJ33A	1.5SMBJ33CA	GFM	BFM	33.0	36.70~40.60	1	53.3	28.2	1
1.5SMBJ36A	1.5SMBJ36CA	GFP	BFP	36.0	40.00~44.20	1	58.1	25.9	1
1.5SMBJ40A	1.5SMBJ40CA	GFR	BFR	40.0	44.40~49.10	1	64.5	23.3	1
1.5SMBJ43A	1.5SMBJ43CA	GFT	BFT	43.0	47.80~52.80	1	69.4	21.7	1
1.5SMBJ45A	1.5SMBJ45CA	GFV	BFV	45.0	50.00~55.30	1	72.7	20.6	1
1.5SMBJ48A	1.5SMBJ48CA	GFX	BFX	48.0	53.30~58.90	1	77.4	19.4	1
1.5SMBJ51A	1.5SMBJ51CA	GFZ	BFZ	51.0	56.70~62.70	1	82.4	18.2	1
1.5SMBJ54A	1.5SMBJ54CA	GGE	BGE	54.0	60.00~66.30	1	87.1	17.3	1
1.5SMBJ58A	1.5SMBJ58CA	GGG	BGG	58.0	64.40~71.20	1	93.6	16.1	1
1.5SMBJ60A	1.5SMBJ60CA	GGK	BGK	60.0	66.70~73.70	1	96.8	15.5	1
1.5SMBJ64A	1.5SMBJ64CA	GGM	BGM	64.0	71.10~78.60	1	103.0	14.6	1
1.5SMBJ70A	1.5SMBJ70CA	GGP	BGP	70.0	77.80~86.00	1	113.0	13.3	1
1.5SMBJ75A	1.5SMBJ75CA	GGR	BGR	75.0	83.30~92.10	1	121.0	12.4	1
1.5SMBJ78A	1.5SMBJ78CA	GGT	BGT	78.0	86.70~95.80	1	126.0	11.9	1
1.5SMBJ85A	1.5SMBJ85CA	GGV	BGV	85.0	94.40~104.00	1	137.0	11.0	1
1.5SMBJ90A	1.5SMBJ90CA	GGX	BGX	90.0	100.00~111.00	1	146.0	10.3	1
1.5SMBJ100A	1.5SMBJ100CA	GGZ	BGZ	100.0	111.00~123.00	1	162.0	9.3	1
1.5SMBJ110A	1.5SMBJ110CA	GHE	BHE	110.0	122.00~135.00	1	177.0	8.5	1
1.5SMBJ120A	1.5SMBJ120CA	GHG	BHG	120.0	133.00~147.00	1	193.0	7.8	1
1.5SMBJ130A	1.5SMBJ130CA	GHK	BHK	130.0	144.00~159.00	1	209.0	7.2	1

Ratings and Characteristic Curves ( $T_A=25^\circ\text{C}$  unless otherwise noted)

Figure 1. Peak Pulse Power Rating Curve

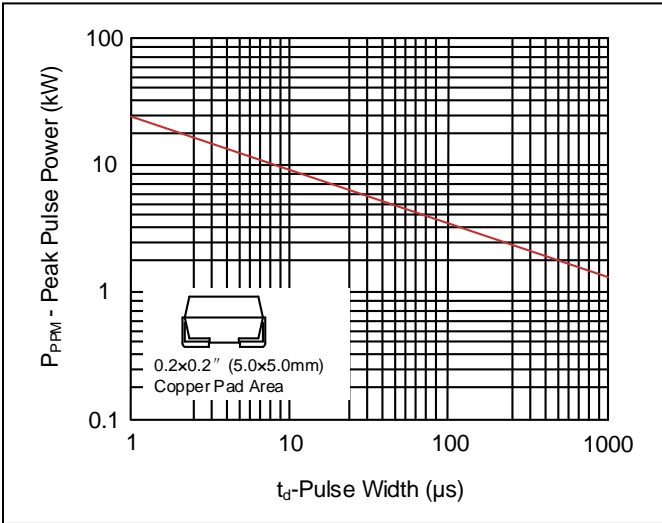

Figure 2. Pulse Derating Curve

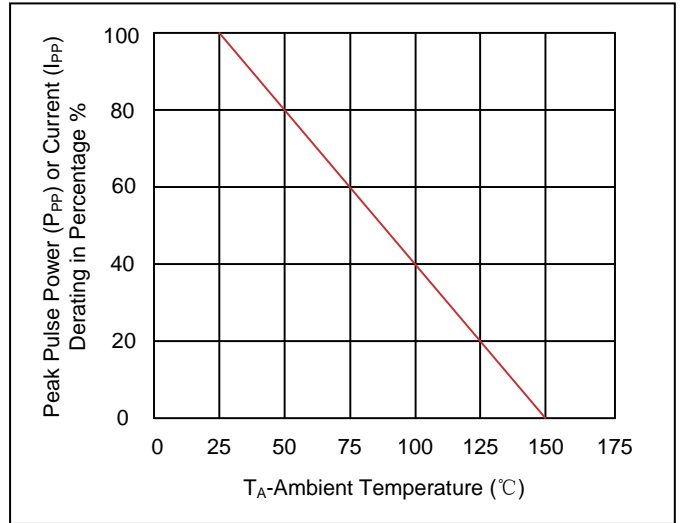

Figure 3. Pulse Waveform

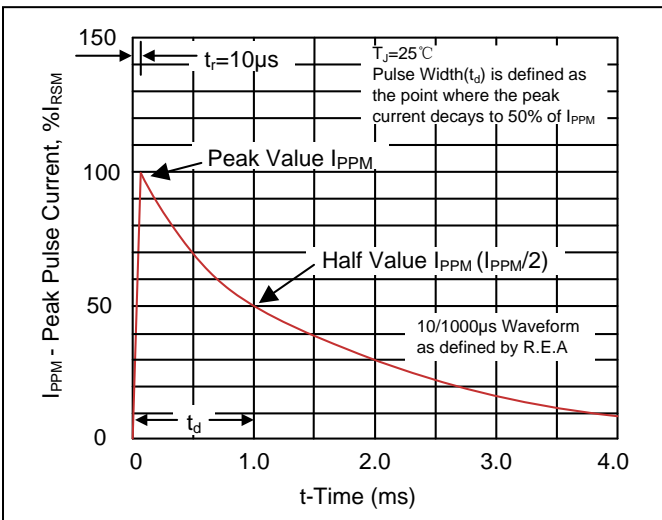

Figure 4. Typical Junction Capacitance

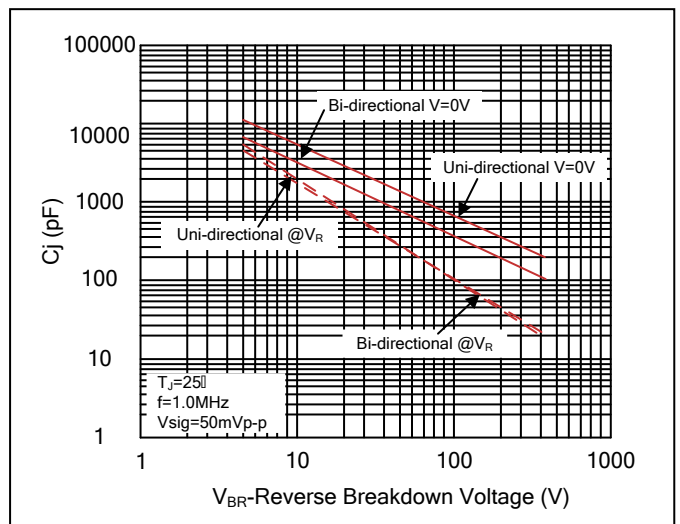

Figure 5. Steady State Power Dissipation Derating Curve

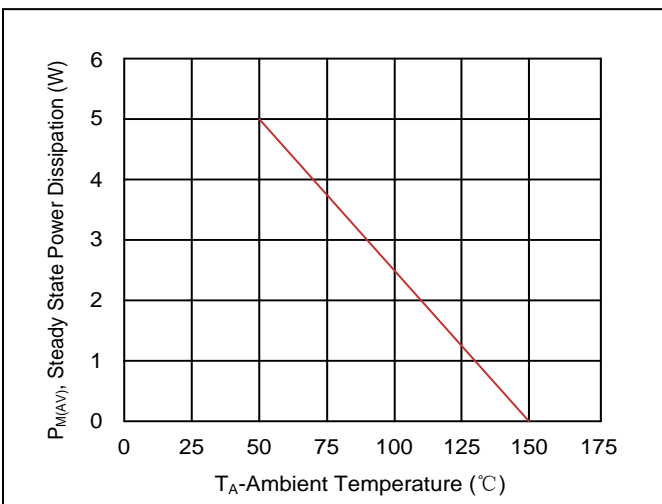
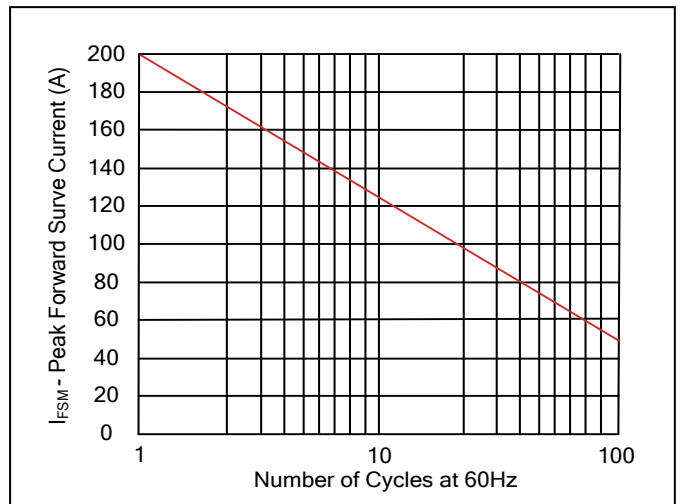
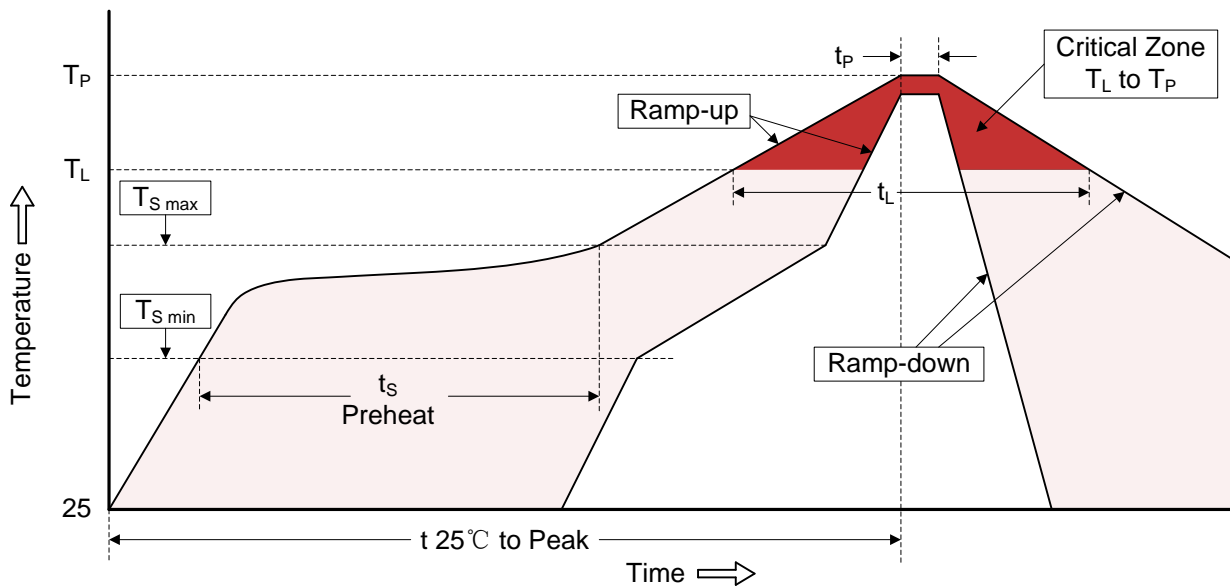

Figure 6. Maximum Non-Repetitive Forward Surge Current Uni-Directional Only



**Recommended Soldering Conditions**

Reflow Soldering



Recommended Conditions

Profile Feature	Pb-Free Assembly
Average ramp-up rate ( $T_L$ to $T_P$ )	3°C/second max.
Preheat	
-Temperature Min ( $T_{S\ min}$ )	150°C
-Temperature Max ( $T_{S\ max}$ )	200°C
-Time (min to max) ( $t_s$ )	60-180 seconds
$T_{S\ max}$ to $T_L$	
-Ramp-up Rate	3°C/second max.
Time maintained above:	
-Temperature ( $T_L$ )	217°C
-Time ( $t_L$ )	60-150 seconds
Peak Temperature ( $T_P$ )	260°C
Time within 5°C of actual Peak Temperature ( $t_P$ )	20-40 seconds
Ramp-down Rate	6°C/second max.
Time 25°C to Peak Temperature	8 minutes max.

**Marking Code**

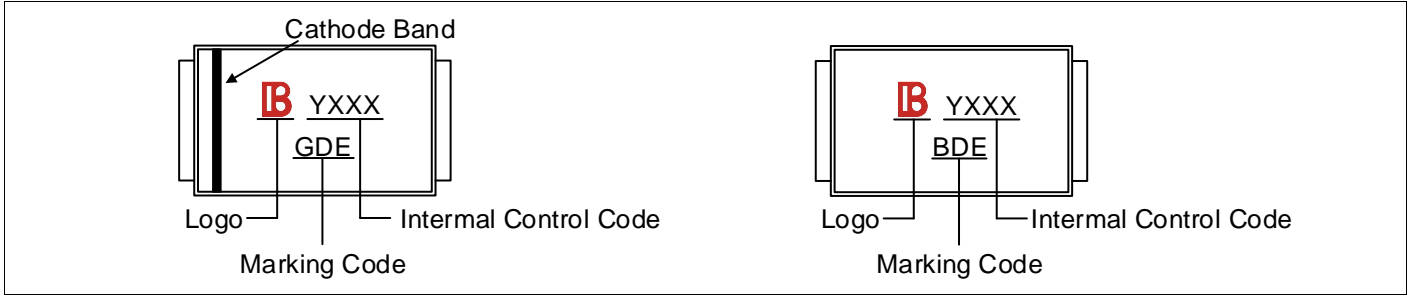

**Part Number Code**

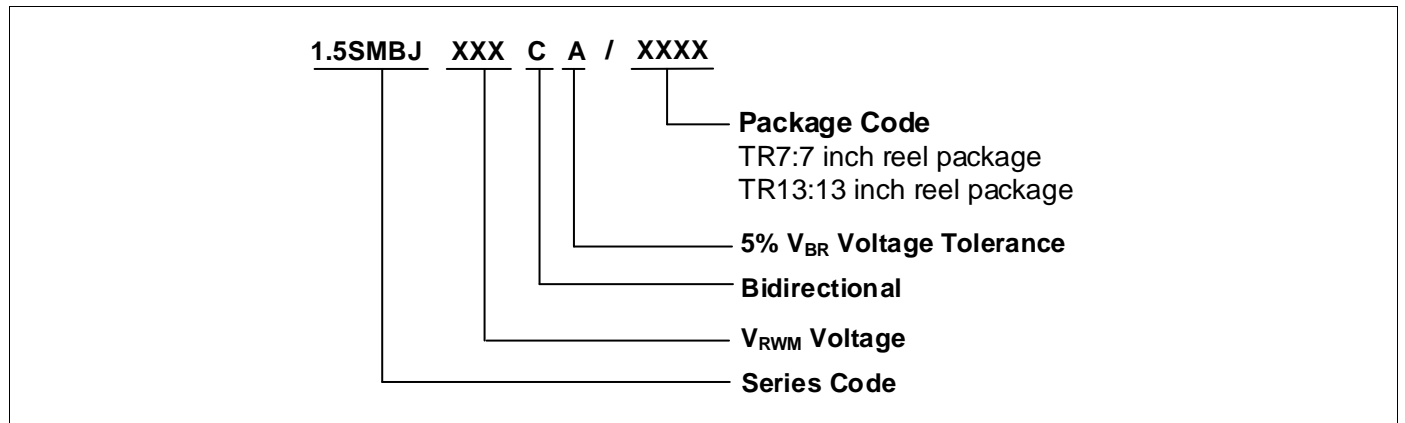

**Ordering Code for Different Package**

7 inch reel package: Add suffix “ /TR7 ” at the end of the part number, such as 1.5SMBJXXXCA/TR7

13 inch reel package: Add suffix “ /TR13 ” at the end of the part number, such as 1.5SMBJXXXCA/TR13

**Packaging**

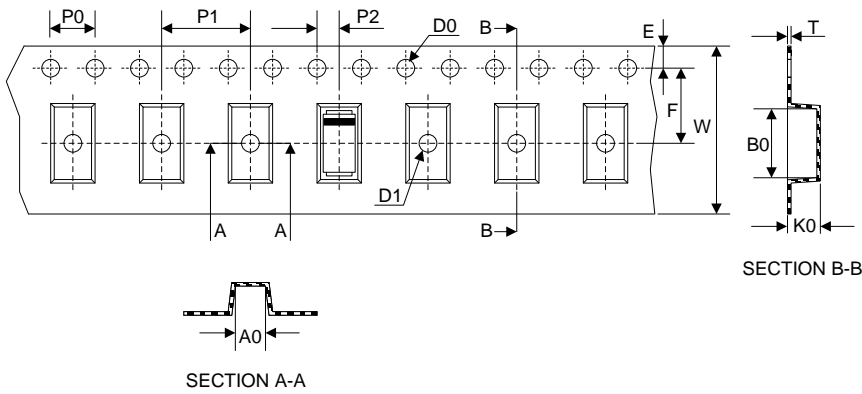
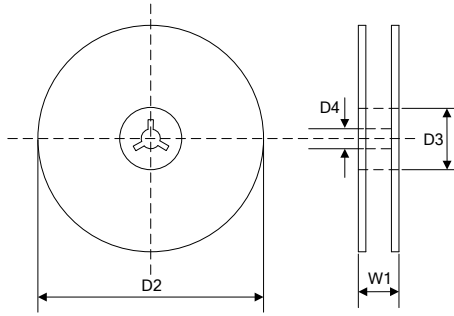
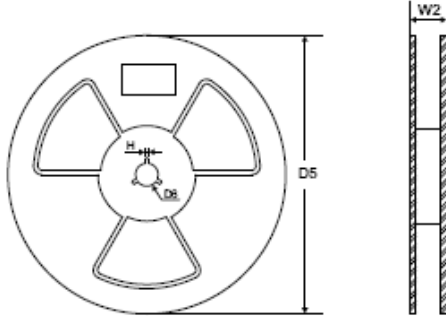
Tape	Symbol	Dimension (mm)
	W	12.00±0.20
	P0	4.00±0.10
	P1	8.00±0.10
	P2	2.00±0.10
	D0	Φ1.55±0.10
	D1	Φ1.5±0.10
	E	1.75±0.10
	F	5.50±0.10
	A0	3.86±0.15
	B0	5.65±0.10
	K0	2.75±0.15
	T	0.25±0.05
	<p>7" Reel</p> 	D2
D3		Φ50.0Min.
D4		Φ13.0±0.5
W1		16.0±2.0
Quantity: 500PCS		
<p>13" Reel</p> 	D5	Φ330.0±2.0
	D6	Φ13.5±0.5
	H	2.5±1.0
	W2	16.0±2.0
	Quantity: 3000PCS	



## LEGAL DISCLAIMER

YAGEO, its distributors and agents (collectively, "YAGEO"), hereby disclaims any and all liabilities for any errors, inaccuracies or incompleteness contained in any product related information, including but not limited to product specifications, datasheets, pictures and/or graphics. YAGEO may make changes, modifications and/or improvements to product related information at any time and without notice.

YAGEO makes no representation, warranty, and/or guarantee about the fitness of its products for any particular purpose or the continuing production of any of its products. To the maximum extent permitted by law, YAGEO disclaims (i) any and all liability arising out of the application or use of any YAGEO product, (ii) any and all liability, including without limitation special, consequential or incidental damages, and (iii) any and all implied warranties, including warranties of fitness for a particular purpose, non-infringement and merchantability.

YAGEO products are designed for general purpose applications under normal operation and usage conditions. Please contact YAGEO for the applications listed below which require especially high reliability for the prevention of defects which might directly cause damage to the third party's life, body or property: Aerospace equipment (artificial satellite, rocket, etc.), Atomic energy-related equipment, Aviation equipment, Disaster prevention equipment, crime prevention equipment, Electric heating apparatus, burning equipment, Highly public information network equipment, data-processing equipment, Medical devices, Military equipment, Power generation control equipment, Safety equipment, Traffic signal equipment, Transportation equipment and Undersea equipment, or for any other application or use in which the failure of YAGEO products could result in personal injury or death, or serious property damage. Particularly **YAGEO Corporation and its affiliates do not recommend the use of commercial or automotive grade products for high reliability applications or manned space flight.**

Information provided here is intended to indicate product specifications only. YAGEO reserves all the rights for revising this content without further notification, as long as products are unchanged. Any product change will be announced by PCN.