



# X0202/A/B

**SCR**

## SENSITIVE SCRS

### DESCRIPTION

The UTC **X0202/A/B** SCR series is suitable for all applications where the available gate current is limited, such as ground fault circuit interruptors, overvoltage crowbar protection in low power supplies, capacitive ignition circuit, .....

### FEATURES

- \*  $I_{T(RMS)}$  : 1.25A
- \*  $V_{DRM}/V_{RRM}$  : 600/800/1000V

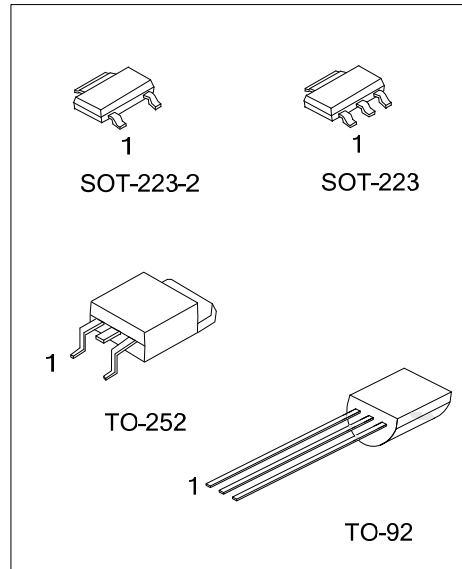

### ORDERING INFORMATION

Ordering Number		Package	Pin Assignment			Packing
Lead Free	Halogen Free		1	2	3	
X0202L-x-AA2-R	X0202G-x-AA2-R	SOT-223-2	K	A	G	Tape Reel
X0202L-x-AA3-R	X0202G-x-AA3-R	SOT-223	K	A	G	Tape Reel
X0202L-x-TN3-R	X0202G-x-TN3-R	TO-252	K	A	G	Tape Reel
X0202L-x-T92-B	X0202G-x-T92-B	TO-92	K	G	A	Tape Box
X0202L-x-T92-K	X0202G-x-T92-K	TO-92	K	G	A	Bulk
X0202L-x-T92-R	X0202G-x-T92-R	TO-92	K	G	A	Tape Reel
X0202xL-x-AA2-R	X0202xG-x-AA2-R	SOT-223-2	K	A	G	Tape Reel
X0202xL-x-AA3-R	X0202xG-x-AA3-R	SOT-223	K	A	G	Tape Reel
X0202xL-x-TN3-R	X0202xG-x-TN3-R	TO-252	K	A	G	Tape Reel
X0202xL-x-T92-B	X0202xG-x-T92-B	TO-92	K	G	A	Tape Box
X0202xL-x-T92-K	X0202xG-x-T92-K	TO-92	K	G	A	Bulk
X0202xL-x-T92-R	X0202xG-x-T92-R	TO-92	K	G	A	Tape Reel

Note: Pin Assignment: K: Cathode G: Gate A: Anode

<p>X0202xG-x-AA2-R</p> <p>(1)Packing Type (2)Package Type (3)Rank (4)Green Package (5)Peak Voltage</p>	<p>(1) B: Tape Box, K: Bulk, R: Tape Reel (2) AA2: SOT-223-2, AA3: SOT-223, T92: TO-92 TN3: TO-252 (3) xx: refer to Classification of <math>I_{GT}</math> (4) G: Halogen Free and Lead Free, L: Lead Free (5) Blank: 600V, A: 800V, B: 1000V</p>
--	--

■ MARKING

Package	MARKING	
	X0202	X0202x
SOT-223-2 SOT-223	<p>X0202 □□□□ 1</p> <p>L: Lead Free G: Halogen Free Data Code</p>	<p>X0202x □□□□ 1</p> <p><math>V_{DRM}, V_{RRM}</math> L: Lead Free G: Halogen Free Data Code</p>
TO-252	<p>UTC X0202 □□□□□□ 1</p> <p>Lot Code ←</p> <p>L: Lead Free G: Halogen Free Data Code</p>	<p>UTC X0202x □□□□□□ 1</p> <p>Lot Code ←</p> <p><math>V_{DRM}, V_{RRM}</math> L: Lead Free G: Halogen Free Data Code</p>
TO-92	<p>UTC X0202 □□□ 1</p> <p>L: Lead Free G: Halogen Free Data Code</p>	<p>UTC X0202x □□□ 1</p> <p>Peak Voltage L: Lead Free G: Halogen Free Data Code</p>

■ ABSOLUTE MAXIMUM RATINGS (unless otherwise specified)

PARAMETERS		SYMBOL	RATINGS	UNIT
Peak Repetitive Forward and Reverse Blocking Voltage ( $T_J=110^\circ\text{C}$ , $R_{GK}=1\text{k}\Omega$ )	X0202	$V_{DRM}$ , $V_{RRM}$	600	V
	X0202A		800	V
	X0202B		1000	V
RMS On-State Current 180°C Conduction Angle	$T_{tab}=95^\circ\text{C}$	$I_{T(RMS)}$	1.25	A
Average On-State Current 180°C Conduction Angle	$T_{tab}=95^\circ\text{C}$	$I_{T(AV)}$	0.8	A
Non Repetitive Surge Peak on-State Current ( $t_p=8.3\text{ms}$ $T_J=25^\circ\text{C}$ )		$I_{TSM}$	25	A
Non Repetitive Surge Peak on-State Current ( $t_p=10\text{ms}$ $T_J=25^\circ\text{C}$ )		$I_{TSM}$	22.5	A
$I^2t$ Value for Fusing ( $t_p=10\text{ms}$ $T_J=25^\circ\text{C}$ )		$I^2t$	2.5	$\text{A}^2\text{S}$
Critical Rate Of Rise Of On-state Current $I_G=2 \times I_{GT}$ , $t_r \leq 100\text{ns}$ , $f=60\text{Hz}$ , $T_J=125^\circ\text{C}$		$di/dt$	50	$\text{A}/\mu\text{s}$
Peak Gate Current ( $p=20\mu\text{s}$ $T_J=125^\circ\text{C}$ )		$I_{GM}$	1.2	A
Average Gate Power Dissipation ( $T_J=125^\circ\text{C}$ )		$P_{G(AV)}$	0.2	W
Operating Junction Temperature Range		$T_J$	-40 ~ +125	$^\circ\text{C}$
Storage Junction Temperature Range		$T_{STG}$	-40 ~ +150	$^\circ\text{C}$

Note: Absolute maximum ratings are those values beyond which the device could be permanently damaged.

Absolute maximum ratings are stress ratings only and functional device operation is not implied.

■ THERMAL DATA

PARAMETER		SYMBOL	RATINGS	UNIT
Junction to Ambient (S=5cm)	SOT-223-2	$\theta_{JA}$	60	$^\circ\text{C}/\text{W}$
	SOT-223			
	TO-252		110	$^\circ\text{C}/\text{W}$
	TO-92			
Typical Thermal Resistance	SOT-223-2	$\theta_{JT}$	25	$^\circ\text{C}/\text{W}$
	SOT-223			
	TO-252	$\theta_{JC}$	6	$^\circ\text{C}/\text{W}$
	TO-92	$\theta_{JL}$	60	$^\circ\text{C}/\text{W}$

S=Copper surface under tab

■ ELECTRICAL CHARACTERISTI

PARAMETER		SYMBOL	TEST CONDITIONS	MIN	TYP	MAX	UNIT
Peak Forward or Reverse Blocking Current	$T_J=25^\circ\text{C}$	$I_{DRM}$ , $I_{RRM}$	$V_{DRM}=V_{RRM}$ , $R_{GK}=1\text{k}\Omega$			5	$\mu\text{A}$
	$T_J=125^\circ\text{C}$					500	$\mu\text{A}$
Peak Forward On-State Voltage		$V_{TM}$	$I_{TM}=2.5\text{A}$ , $t_p=380\mu\text{s}$			1.45	V
Gate Trigger Current		$I_{GT}$	$V_D=12\text{V}$ , $R_L=140\Omega$	10		200	$\mu\text{A}$
Gate Trigger Voltage		$V_{GT}$	$V_D=12\text{V}$ , $R_L=140\Omega$			0.8	V
Gate Non-Trigger Voltage		$V_{GD}$	$V_D=V_{DRM}$ , $R_L=3.3\text{k}\Omega$ , $R_{GK}=1\text{k}\Omega$ , ( $T_J=125^\circ\text{C}$ )	0.1			V
Holding Current		$I_H$	$I_T=50\text{mA}$ , $R_{GK}=1\text{k}\Omega$			5	mA
Latch Current		$I_L$	$I_G=1\text{mA}$ , $R_{GK}=1\text{k}\Omega$			6	mA
Critical Rate of Rise of Off-State Voltage		$dv/dt$	$V_D=67\%V_{DRM}$ , $R_{GK}=1\text{k}\Omega$ , ( $T_J=110^\circ\text{C}$ )	10			$\text{V}/\mu\text{s}$
Peak Reversed Gate Voltage		$V_{RG}$	$I_{RG}=10\mu\text{A}$	8			V
Threshold Voltage		$V_{TO}$	( $T_J=125^\circ\text{C}$ )			0.9	V
Dynamic Resistance		$R_d$	( $T_J=125^\circ\text{C}$ )			200	$\text{m}\Omega$

■ CLASSIFICATION OF  $I_{GT}$

RANK	A	B
RANGE	10~100 $\mu\text{A}$	90~200 $\mu\text{A}$

■ TYPICAL CHARACTERISTICS

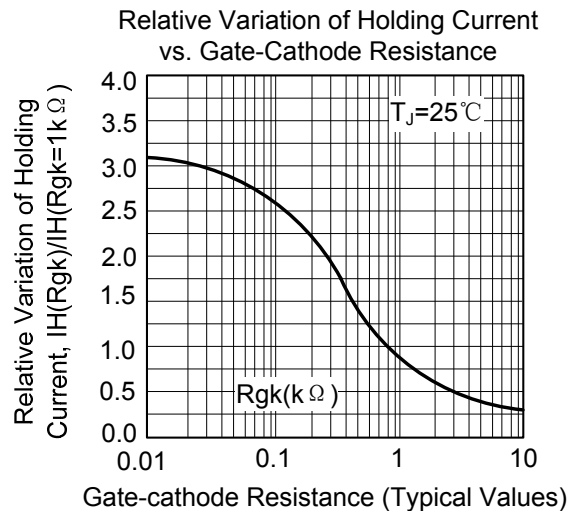
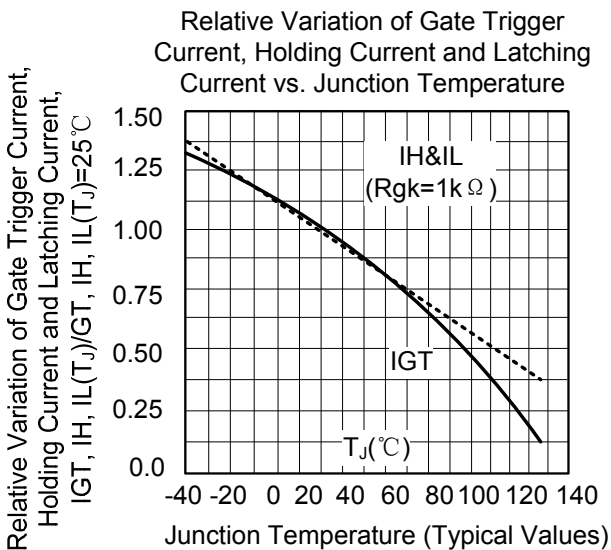
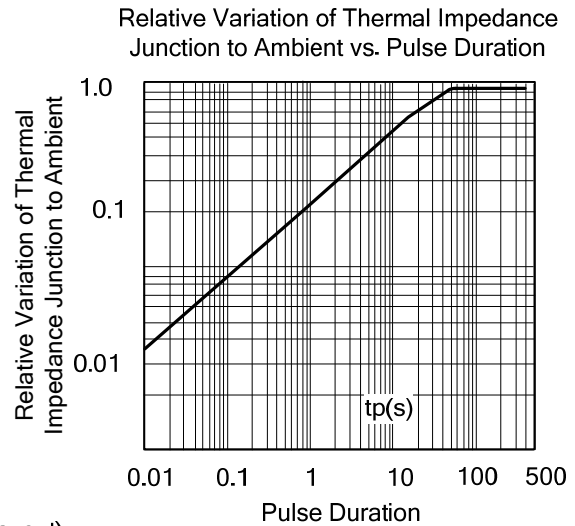
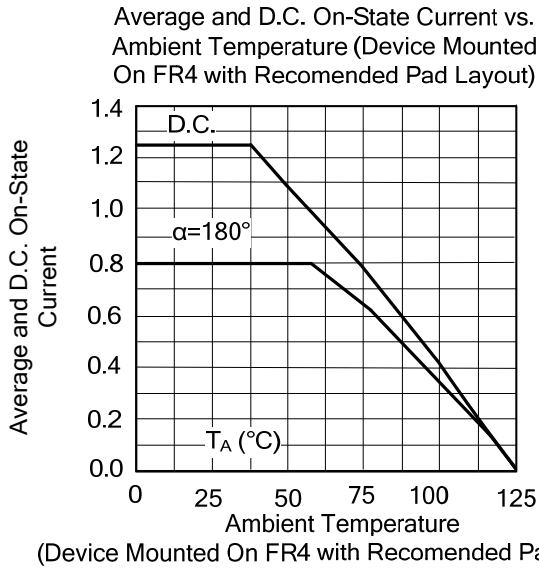
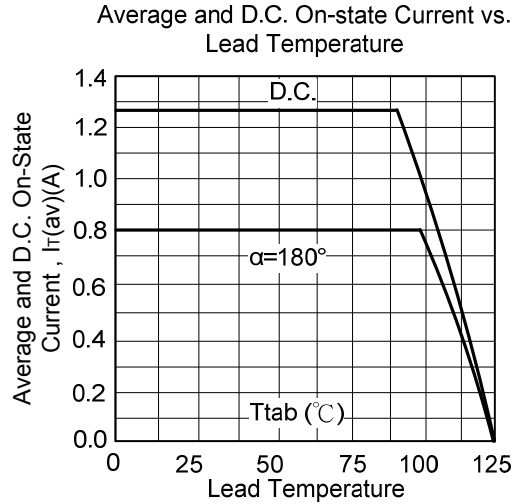
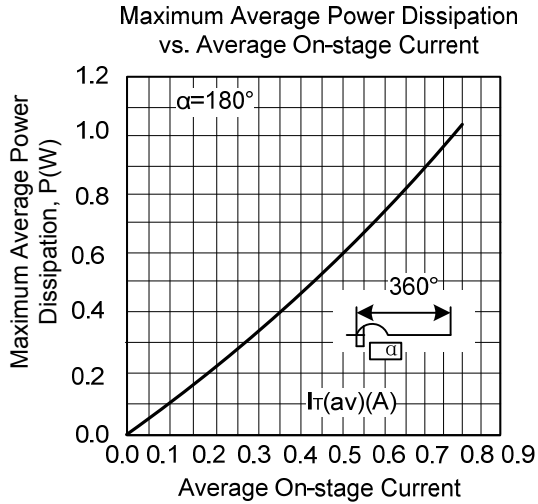

■ TYPICAL CHARACTERISTICS(Cont.)

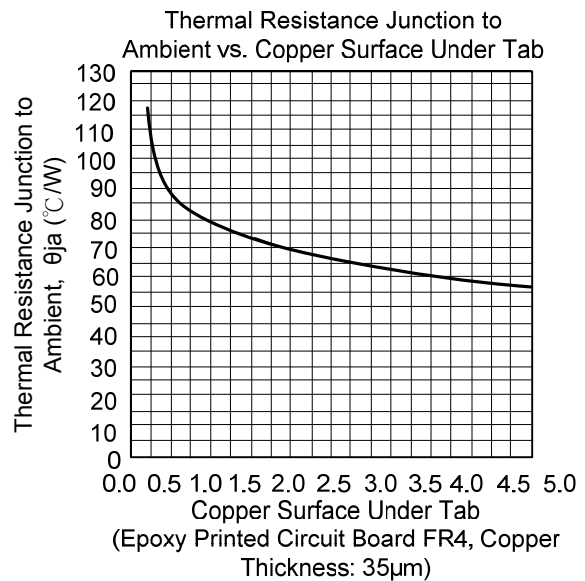
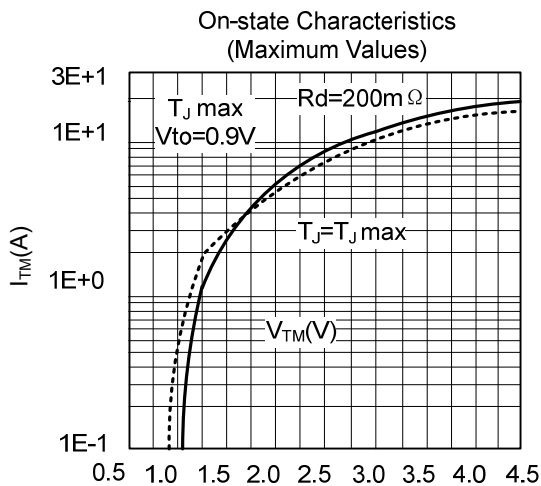
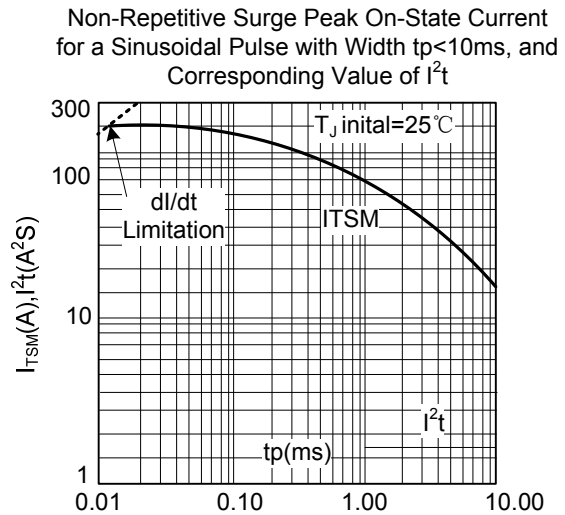
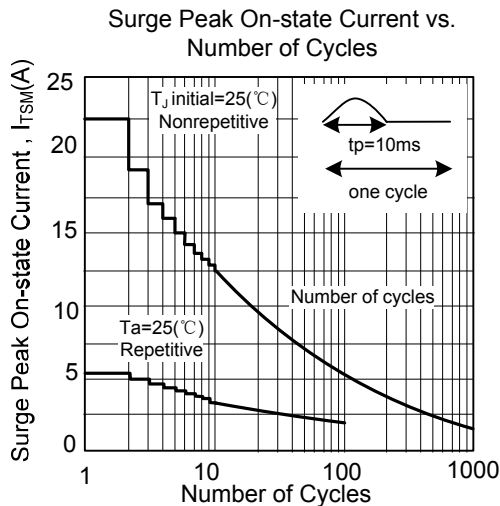
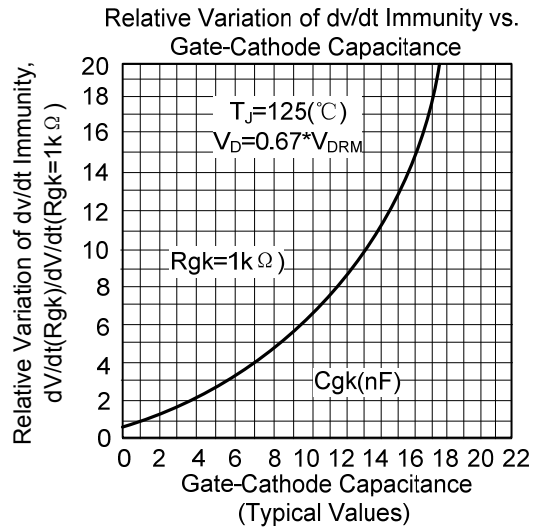
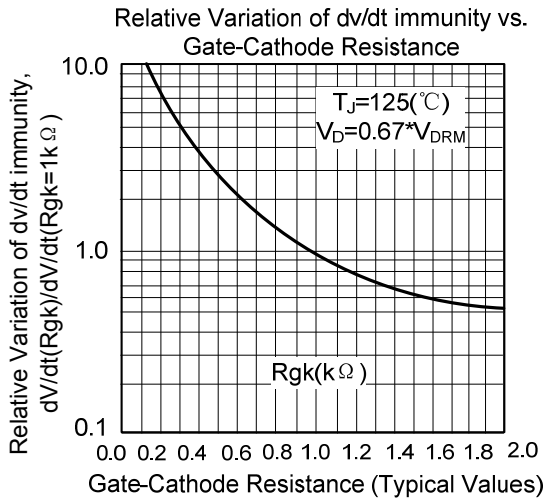

UTC assumes no responsibility for equipment failures that result from using products at values that exceed, even momentarily, rated values (such as maximum ratings, operating condition ranges, or other parameters) listed in products specifications of any and all UTC products described or contained herein. UTC products are not designed for use in life support appliances, devices or systems where malfunction of these products can be reasonably expected to result in personal injury. Reproduction in whole or in part is prohibited without the prior written consent of the copyright owner. UTC reserves the right to make changes to information published in this document, including without limitation specifications and product descriptions, at any time and without notice. This document supersedes and replaces all information supplied prior to the publication hereof.