

DATA SHEET

METAL OXIDE VARISTORS POWER SUPPLY

20H Series

RoHS compliant & Halogen free



Product specification— April 11, 2022 V.0

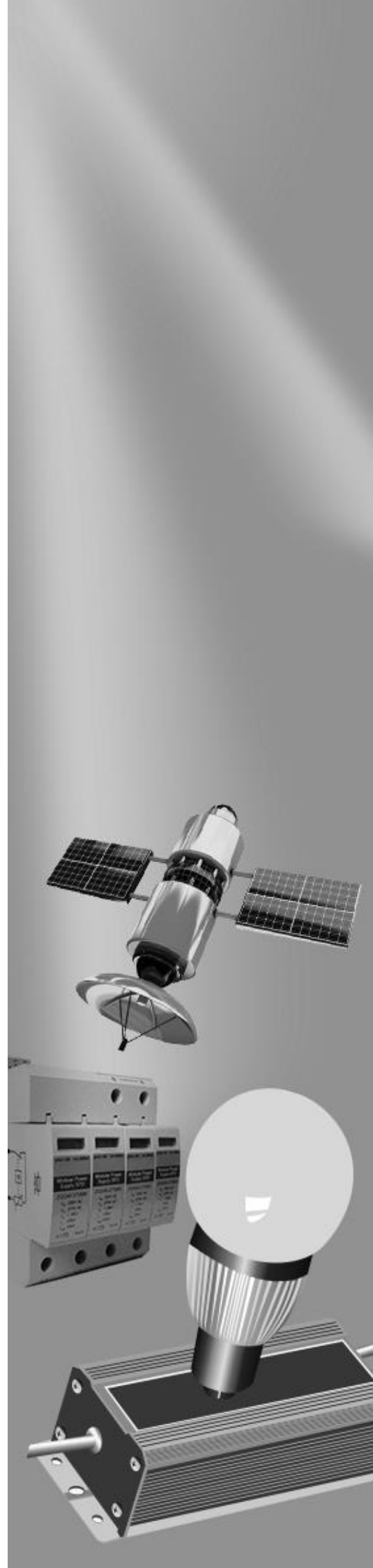

Metal Oxide Varistors (MOV) Data Sheet

Features

- Wide operating voltage (V1mA) range from 18V to 1800V
- Fast responding to transient over-voltage
- Large absorbing transient energy capability
- Low clamping ratio and no follow-on current
- Meets MSL level 1, per J-STD-020
- Operating Temperature: -40°C ~ +140°C
- Storage Temperature: -40°C ~ +140°C
- Safety certification: UL: E327997
TUV: B0960480010
CQC:17001172545
CSA: 246579



Applications

- Transistor, diode, IC, thyristor or triac semiconductor protection
- Surge protection in consumer electronics
- Surge protection in industrial electronics
- Surge protection in electronic home appliances, gas and petroleum appliances
- Relay and electromagnetic valve surge absorption

Part Number Code

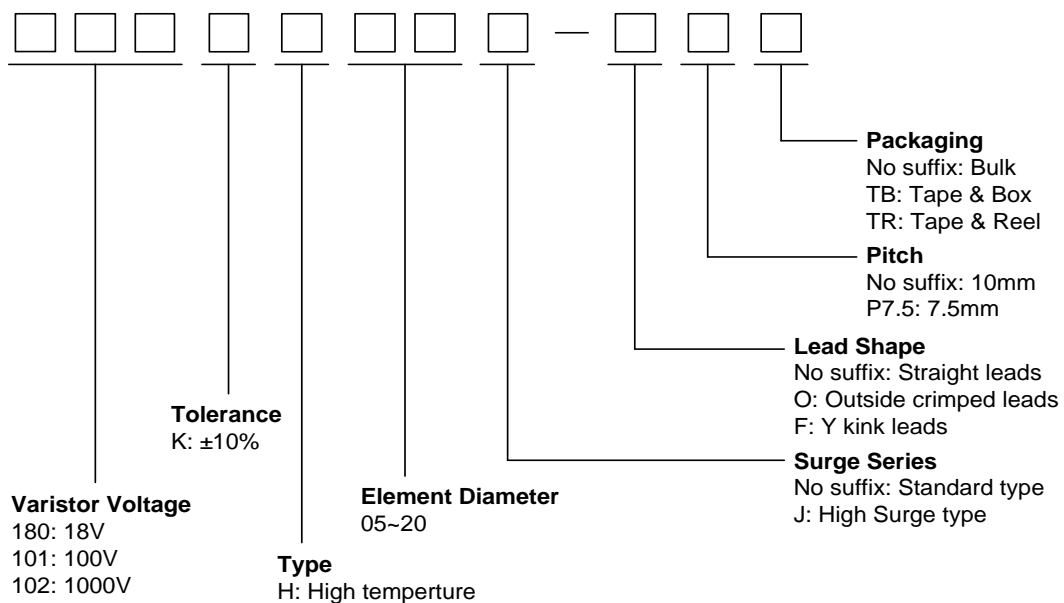

Dimensions

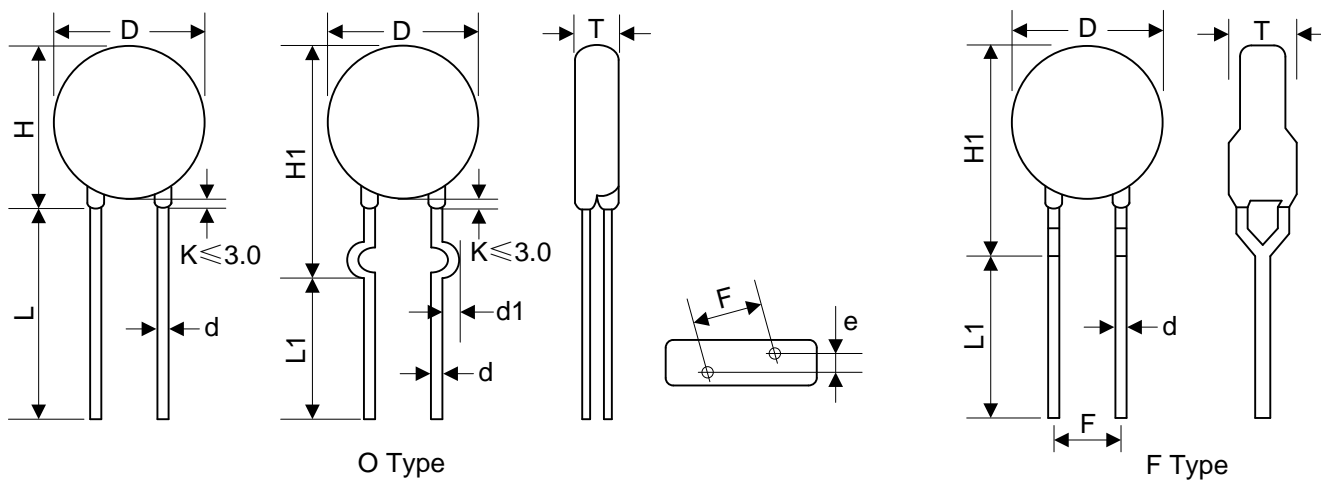

Table 1	
Unit: mm	
Symbol	Dimension
H	19.5~26.5
H1	24.0~30.0
L(min.)	20.0
L1(min.)	15.0
D	19.0~23.5
F	7.5±0.8/10.0±1.0
T	Table 2
e(±0.8)	Table 2
d(±0.05)	0.8/1.0
d1(±0.4)	1.4/1.6

Table 2					
Unit: mm					
Model	T	e	Model	T	e
180K	2.66~5.73	1.7	361K	3.45~6.88	2.9
220K	2.76~5.87	1.8	391K	3.55~7.05	3.0
270K	2.87~6.09	2.0	431K	3.69~7.27	3.2
330K	2.99~6.28	1.9	471K	3.85~7.49	3.4
390K	2.94~6.04	2.0	511K	3.99~7.71	3.6
470K	3.06~6.27	2.1	561K	4.15~7.98	3.8
560K	3.21~6.52	2.3	621K	4.35~8.31	4.1
680K	3.41~6.82	2.4	681K	4.55~8.64	4.4
820K	2.74~5.72	2.0	751K	4.75~9.03	4.5
101K	2.84~5.89	2.2	781K	4.85~9.19	4.6
121K	2.94~6.09	2.4	821K	4.98~9.41	4.8
151K	2.79~5.90	2.0	911K	5.28~9.67	5.0
181K	2.89~6.10	2.1	102K	5.57~10.14	5.3
201K	2.97~6.26	2.2	112K	5.91~10.66	5.6
221K	3.02~6.11	2.3	122K	6.15~11.19	5.9
241K	3.09~6.22	2.4	142K	6.90~12.23	6.1
271K	3.18~6.39	2.6	162K	7.58~13.38	6.7
301K	3.25~6.55	2.7	182K	8.25~14.33	7.1
331K	3.35~6.72	2.7			

METAL OXIDE VARISTORS

20H

Electrical Characteristics

Part Number		Maximum Allowable Voltage		Varistor Voltage	Maximum Clamping Voltage		Withstanding Surge Current		Maximum Energy (10/1000µs)		Rated Power	Typical Capacitance (Reference)
Standard	High Surge	V _{AC} (V)	V _{DC} (V)	V _{1mA} (V)	I _P (A)	V _C (V)	I (A) Standard	I (A) High Surge	(J) Standard	(J) High Surge	(W)	@1KHz (pf)
180KH20	180KH20J	11	14	18(15~21.6)	20	36	2000	3000	11	13	0.2	28500
220KH20	220KH20J	14	18	22(19.5~26)	20	43	2000	3000	14	16	0.2	18500
270KH20	270KH20J	17	22	27(24~31)	20	53	2000	3000	16	19	0.2	13000
330KH20	330KH20J	20	26	33(29.5~36.5)	20	65	2000	3000	23	24	0.2	11500
390KH20	390KH20J	25	31	39(35~43)	20	77	2000	3000	26	28	0.2	8500
470KH20	470KH20J	30	38	47(42~52)	20	93	2000	3000	30	34	0.2	7400
560KH20	560KH20J	35	45	56(50~62)	20	110	2000	3000	38	44	0.2	6500
680KH20	680KH20J	40	56	68(61~75)	20	135	2000	3000	41	49	0.2	5800
820KH20	820KH20J	50	65	82(74~90)	100	135	6500	10000	45	56	1.0	4900
101KH20	101KH20J	60	85	100(90~110)	100	165	6500	10000	50	70	1.0	4000
121KH20	121KH20J	75	100	120(108~132)	100	200	6500	10000	55	85	1.0	3300
151KH20	151KH20J	95	125	150(135~165)	100	250	6500	10000	70	106	1.0	2700
181KH20	181KH20J	115	150	180(162~198)	100	300	6500	10000	85	130	1.0	2200
201KH20	201KH20J	130	170	200(180~220)	100	340	6500	10000	95	140	1.0	2000
221KH20	221KH20J	140	180	220(198~242)	100	360	6500	10000	100	155	1.0	1800
241KH20	241KH20J	150	200	240(216~264)	100	395	6500	10000	108	168	1.0	1650
271KH20	271KH20J	175	225	270(243~297)	100	455	6500	10000	127	190	1.0	1500
301KH20	301KH20J	190	250	300(270~330)	100	500	6500	10000	136	210	1.0	1300
331KH20	331KH20J	210	275	330(297~363)	100	550	6500	10000	150	228	1.0	1200
361KH20	361KH20J	230	300	360(324~396)	100	595	6500	10000	163	255	1.0	1100
391KH20	391KH20J	250	320	390(351~429)	100	650	6500	10000	180	275	1.0	1000
431KH20	431KH20J	275	350	430(387~473)	100	710	6500	10000	190	305	1.0	930
471KH20	471KH20J	300	385	470(423~517)	100	775	6500	10000	204	350	1.0	850
511KH20	511KH20J	320	415	510(459~561)	100	845	6500	10000	210	360	1.0	780
561KH20	561KH20J	350	460	560(504~616)	100	925	6500	10000	215	380	1.0	710
621KH20	621KH20J	385	505	620(558~682)	100	1025	6500	10000	224	390	1.0	650
681KH20	681KH20J	420	560	680(612~748)	100	1120	6500	10000	230	400	1.0	600
751KH20	751KH20J	460	615	750(675~825)	100	1240	6500	10000	255	420	1.0	530
781KH20	781KH20J	485	640	780(702~858)	100	1290	6500	10000	265	440	1.0	510
821KH20	821KH20J	510	670	820(738~902)	100	1355	6500	10000	282	460	1.0	500
911KH20	911KH20J	550	745	910(819~1001)	100	1500	6500	10000	310	510	1.0	440
102KH20	102KH20J	625	825	1000(900~1100)	100	1650	6500	10000	342	565	1.0	400
112KH20	112KH20J	680	895	1100(990~1210)	100	1815	6500	10000	383	620	1.0	360
122KH20	122KH20J	750	990	1200(1080~1320)	100	1980	6500	10000	408	660	1.0	350
142KH20	142KH20J	880	1140	1400(1260~1540)	100	2310	6500	10000	532	784	1.0	340
162KH20	162KH20J	1000	1280	1600(1440~1760)	100	2640	6500	10000	606	896	1.0	330
182KH20	182KH20J	1100	1465	1800(1620~1980)	100	2970	6500	10000	625	990	1.0	320

- Notes: 1. The tolerance of varistor voltage between 18V and 27V is more than 10%.
 2. Varistor voltage ≥ 1200V, structure diagram is F type.
 3. Leakage Current (@83% of V_{1mA}): IR ≤ 40µA (180K~680K) ; IR ≤ 20µA (820K~182K)

Electrical Ratings

Items	Test Condition/Description	Requirement					
Varistor Voltage	The voltage between the two terminals with the specified measuring current 1mA.DC applied is called Vb.	To meet the Specified value					
Maximum Allowable Voltage	The recommended maximum sine wave voltage (RMS) or the Maximum DC voltage can be applied continuously.						
Maximum Clamping Voltage	<p>The maximum voltage between the two terminals with the specification standard impulse current. Applied waveform: 8/20µs</p>						
Rated Wattage	The maximum average power that can be applied within the specified ambient temperature.						
Energy	The maximum energy within the varistor voltage change of ±10% when one impulse of 10/1000µs or 2ms is applied.						
Withstanding Surge Current	The maximum current within the varistor voltage change of ±10% with the standard impulse current (8/20µs) applied one time.						
Varistor Voltage Temp. Coefficient	$\left \frac{V_{1mA@140^{\circ}C} - V_{1mA@25^{\circ}C}}{V_{1mA@25^{\circ}C}} \times \frac{1}{115} \times 100\%(\%/^{\circ}C) \right $ $\left \frac{V_{1mA@-40^{\circ}C} - V_{1mA@25^{\circ}C}}{V_{1mA@25^{\circ}C}} \times \frac{1}{65} \times 100\%(\%/^{\circ}C) \right $		≤0.05%/°C				
Surge Life	<p>The change of Vb shall be measured after the impulse listed below which is applied 10,000 times continuously with the interval of ten seconds at room temperature.</p> <table border="1" style="margin-left: auto; margin-right: auto;"> <tr> <td rowspan="2" style="text-align: center;">20Φ series</td> <td style="text-align: center;">180K to 680K</td> <td style="text-align: center;">100A (8/20µs)</td> </tr> <tr> <td style="text-align: center;">820K to 182K</td> <td style="text-align: center;">200A (8/20µs)</td> </tr> </table>	20Φ series	180K to 680K	100A (8/20µs)	820K to 182K	200A (8/20µs)	$\frac{\Delta V_b}{V_b} \leq \pm 10\%$
20Φ series	180K to 680K		100A (8/20µs)				
	820K to 182K	200A (8/20µs)					

Soldering Recommendation

Lead-free Wave Soldering Recommendation

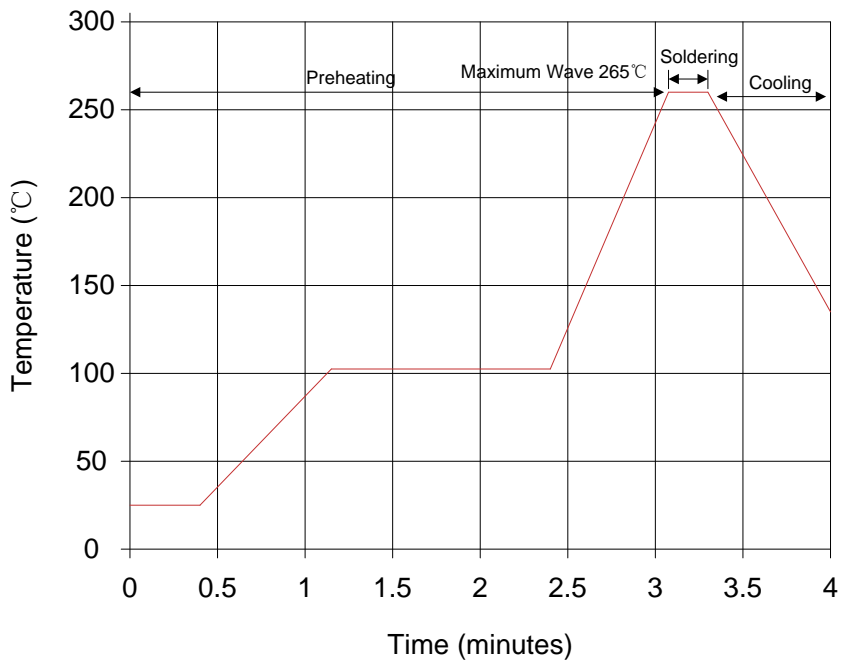

Item	Conditions
Peak Temperature	265°C
Dipping Time	10 seconds (max.)
Soldering	1 time

Recommendation Reworking Conditions with Soldering Iron

Item	Conditions
Temperature of Soldering Iron-tip	360°C (max.)
Soldering Time	3 seconds (max.)
Distance from Varistor	2mm (min.)

Mechanical Characteristics

Items	Test conditions / Methods	Specifications								
Tensile Strength of Terminals	Gradually applying the force specified and keeping the unit fixed for 10±1 sec. <table border="1"> <thead> <tr> <th>Terminal diameter (mm)</th> <th>Force (kg)</th> </tr> </thead> <tbody> <tr> <td>0.5<d≤0.8</td> <td>1.0</td> </tr> <tr> <td>0.8<d≤1.25</td> <td>2.0</td> </tr> <tr> <td>1.25<d</td> <td>4.0</td> </tr> </tbody> </table>	Terminal diameter (mm)	Force (kg)	0.5<d≤0.8	1.0	0.8<d≤1.25	2.0	1.25<d	4.0	No visible damage ΔV _{1mA} /V _{1mA} ≤5%
Terminal diameter (mm)	Force (kg)									
0.5<d≤0.8	1.0									
0.8<d≤1.25	2.0									
1.25<d	4.0									
Bending Strength of Terminals	Hold specimen and apply the force specified below to each lead. Bend the specimen to 90°, then return to the original position. Repeat the procedure in the opposite direction. <table border="1"> <thead> <tr> <th>Terminal diameter (mm)</th> <th>Force (kg)</th> </tr> </thead> <tbody> <tr> <td>0.5<d≤0.8</td> <td>0.5</td> </tr> <tr> <td>0.8<d≤1.25</td> <td>1.0</td> </tr> <tr> <td>1.25<d</td> <td>2.0</td> </tr> </tbody> </table>	Terminal diameter (mm)	Force (kg)	0.5<d≤0.8	0.5	0.8<d≤1.25	1.0	1.25<d	2.0	No visible damage ΔV _{1mA} /V _{1mA} ≤5%
Terminal diameter (mm)	Force (kg)									
0.5<d≤0.8	0.5									
0.8<d≤1.25	1.0									
1.25<d	2.0									
Vibration	Frequency range: 10~55 Hz Amplitude: 0.75mm or 98m/s ² Direction: 3 mutually perpendicular directions, 2hrs each.	No visible damage ΔV _{1mA} /V _{1mA} ≤5%								
Solder ability	Solder Temp: 245±5°C Dipping Time: 2±0.5 sec	At least 95% of terminal electrode is covered by new solder								
Resistance to Soldering Heat	Solder Temp: 260±5°C Dipping Time: 10±1 sec	No visible damage ΔV _{1mA} /V _{1mA} ≤10%								

Reliability

Items	Test conditions / Methods	Specifications															
High Temperature Storage	Ambient Temp: 125±2°C Duration: 1000hrs	ΔV _{1mA} /V _{1mA} ≤5%															
Low Temperature Storage	Ambient Temp: -40±2°C Duration: 1000hrs	ΔV _{1mA} /V _{1mA} ≤5%															
Humidity	Ambient Temp: 40±2°C, 90~95% R.H. Duration: 1000hrs	ΔV _{1mA} /V _{1mA} ≤5%															
Temperature Cycle	The conditions shown below shall be repeated 5 cycles <table border="1"> <thead> <tr> <th>Step</th> <th>Temperature (°C)</th> <th>Period (minutes)</th> </tr> </thead> <tbody> <tr> <td>1</td> <td>-40±3</td> <td>30±3</td> </tr> <tr> <td>2</td> <td>Room temperature</td> <td>15±3</td> </tr> <tr> <td>3</td> <td>125±3</td> <td>30±3</td> </tr> <tr> <td>4</td> <td>Room temperature</td> <td>15±3</td> </tr> </tbody> </table>	Step	Temperature (°C)	Period (minutes)	1	-40±3	30±3	2	Room temperature	15±3	3	125±3	30±3	4	Room temperature	15±3	No visible damage ΔV _{1mA} /V _{1mA} ≤5%
Step	Temperature (°C)	Period (minutes)															
1	-40±3	30±3															
2	Room temperature	15±3															
3	125±3	30±3															
4	Room temperature	15±3															
High Temperature Load	Ambient Temp: 125±2°C Duration: 1000hrs Load: Max. Allowable Voltage In AC eera.	ΔV _{1mA} /V _{1mA} ≤10%															
Damp Heat Load	Ambient Temp: 40±2°C, 90~95% R.H. Duration: 1000hrs Load: Max. Allowable Voltage	No visible damage ΔV _{1mA} /V _{1mA} ≤10%															
Voltage Proof	Metal balls method, 1000Vac 1 min.(180K~331K), 1500Vac 1 min.(361K~182K)	No visible damage															

Power Derating Curve

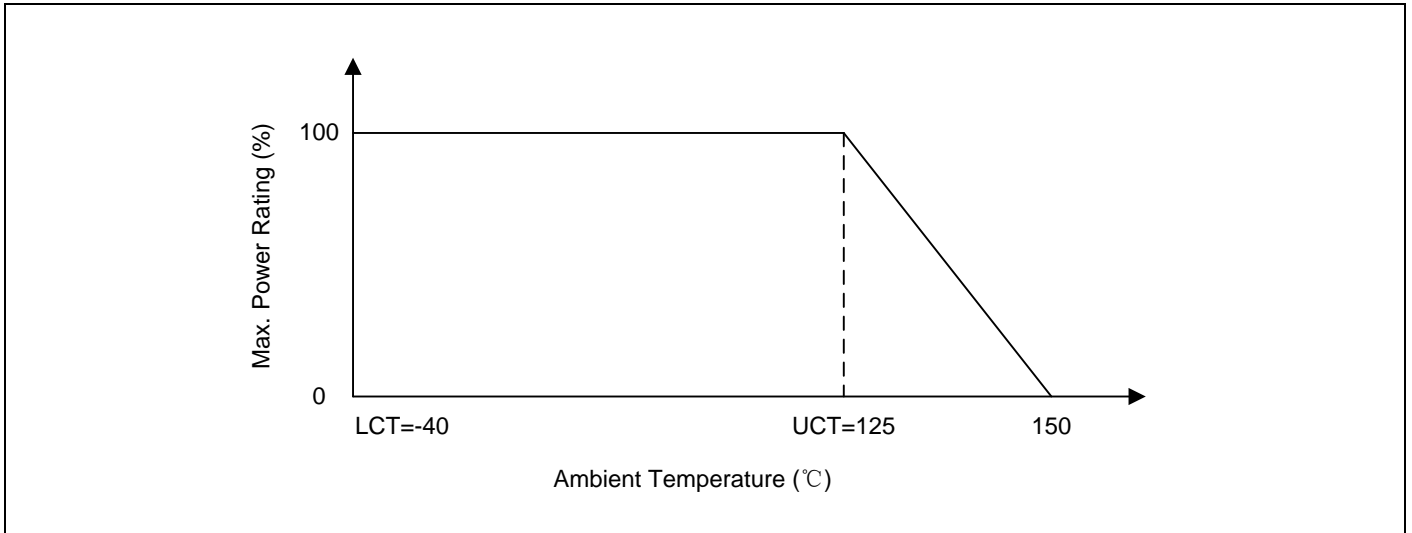

Maximum Surge Current Derating Curve

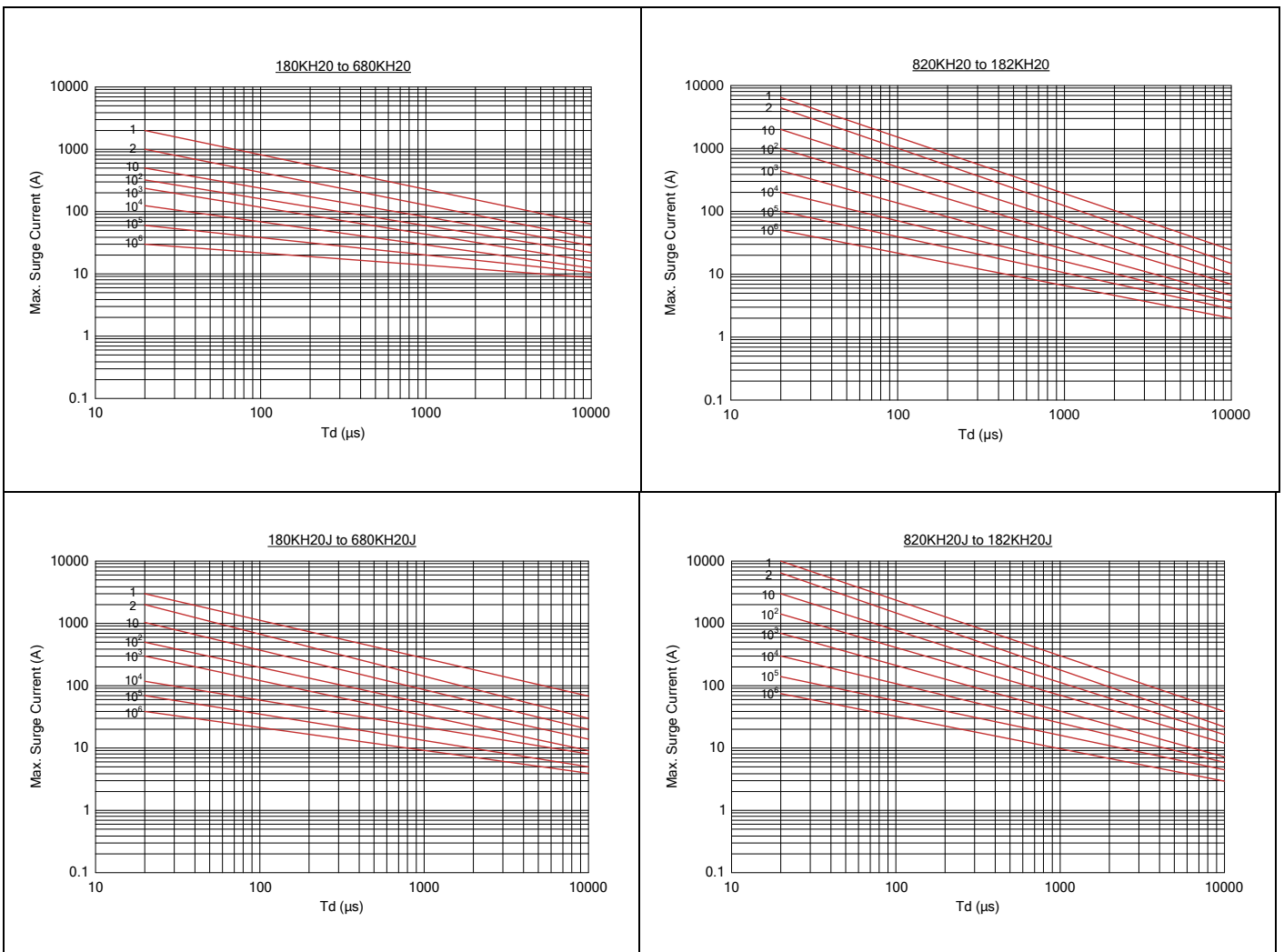

Maximum Leakage Current and Maximum Clamping Voltage Curve

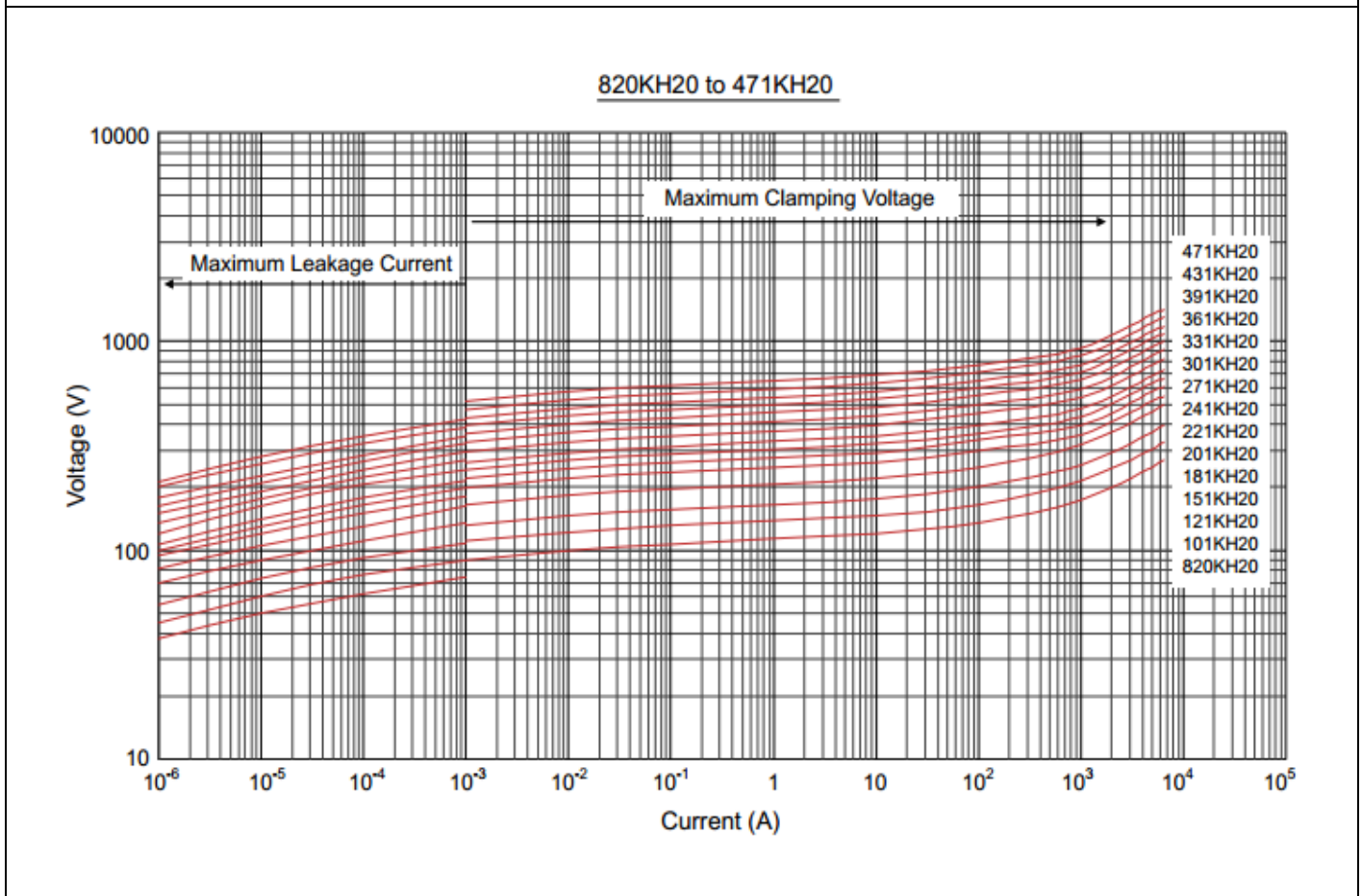
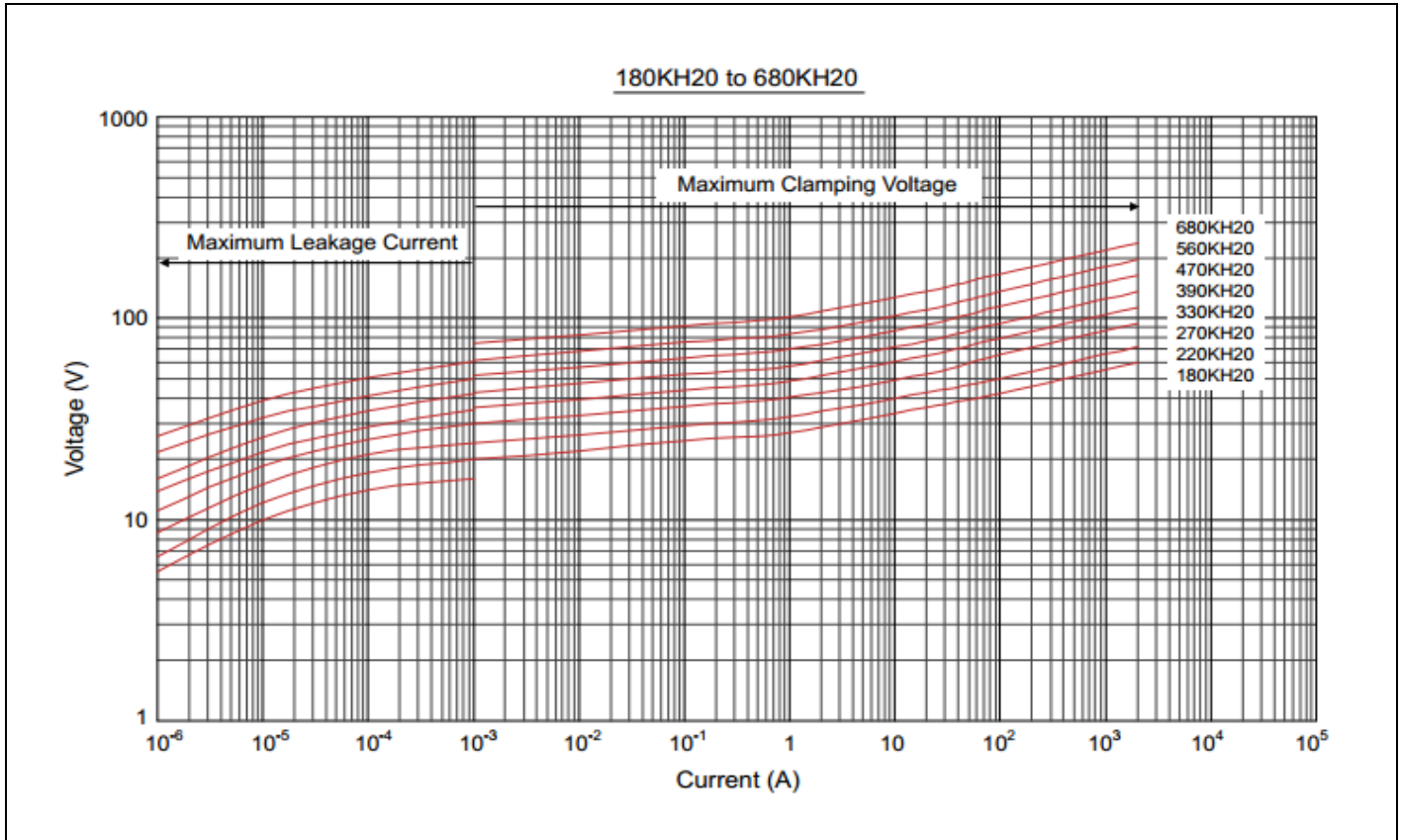

Maximum Leakage Current and Maximum Clamping Voltage Curve

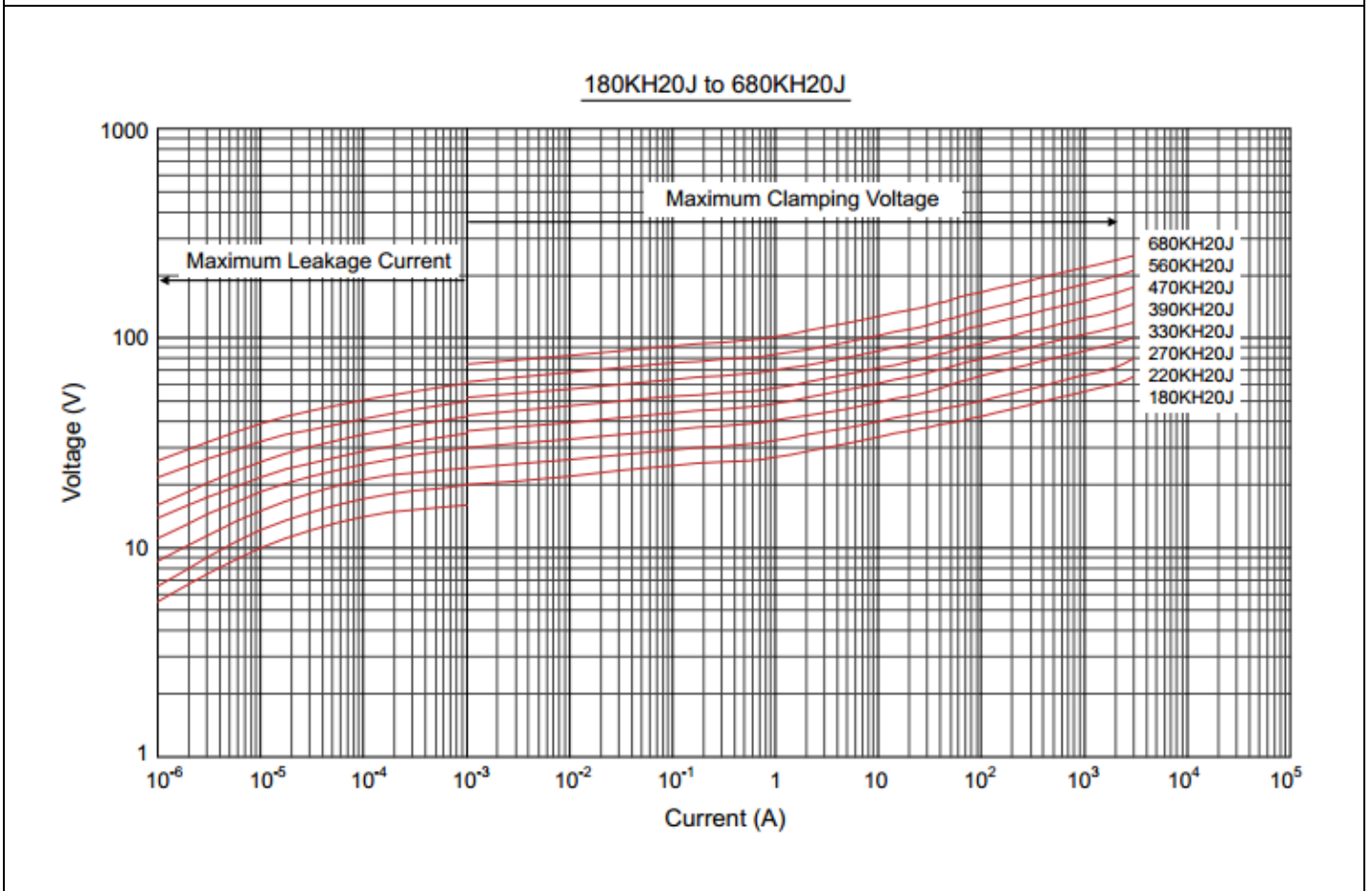
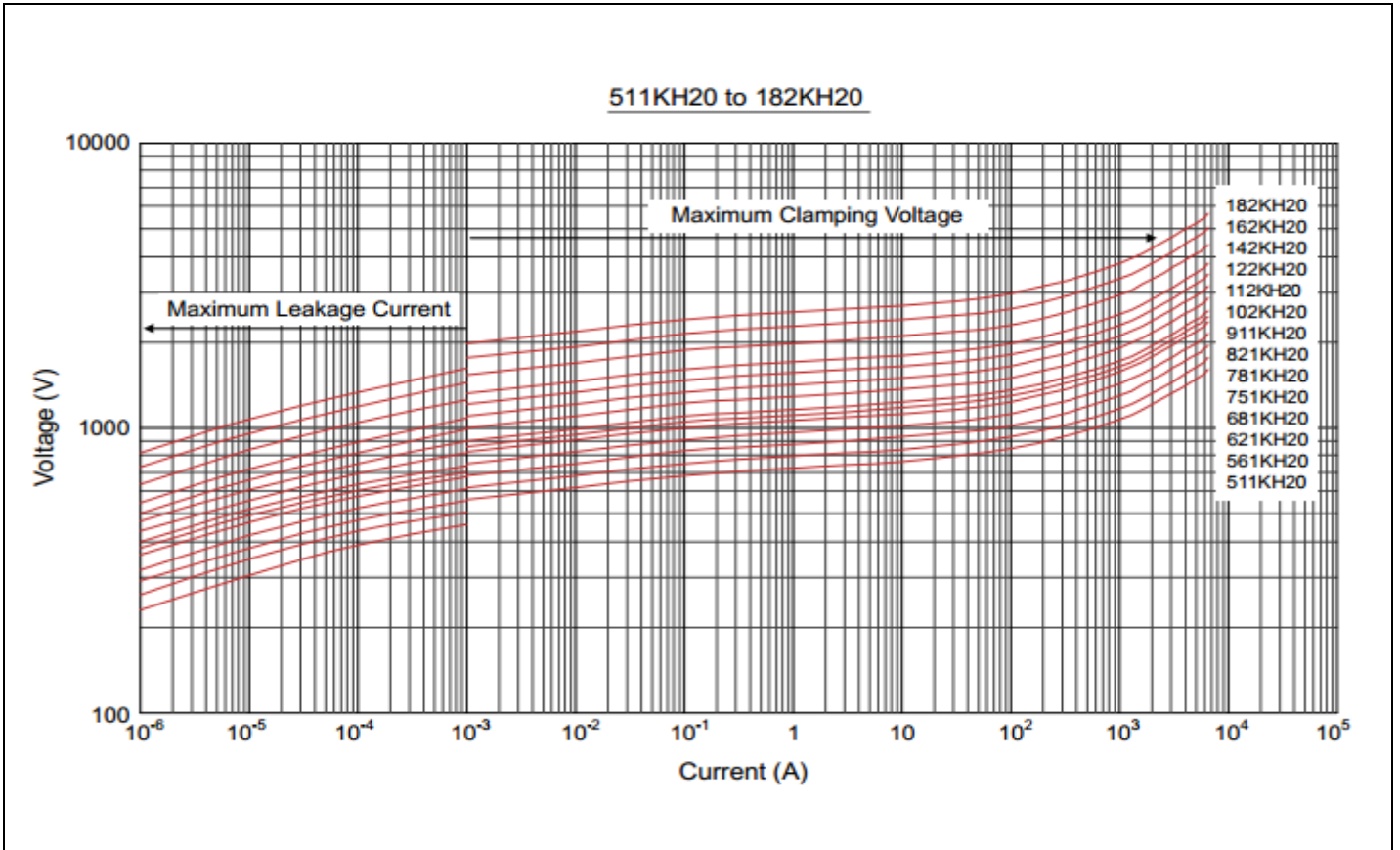

Maximum Leakage Current and Maximum Clamping Voltage Curve

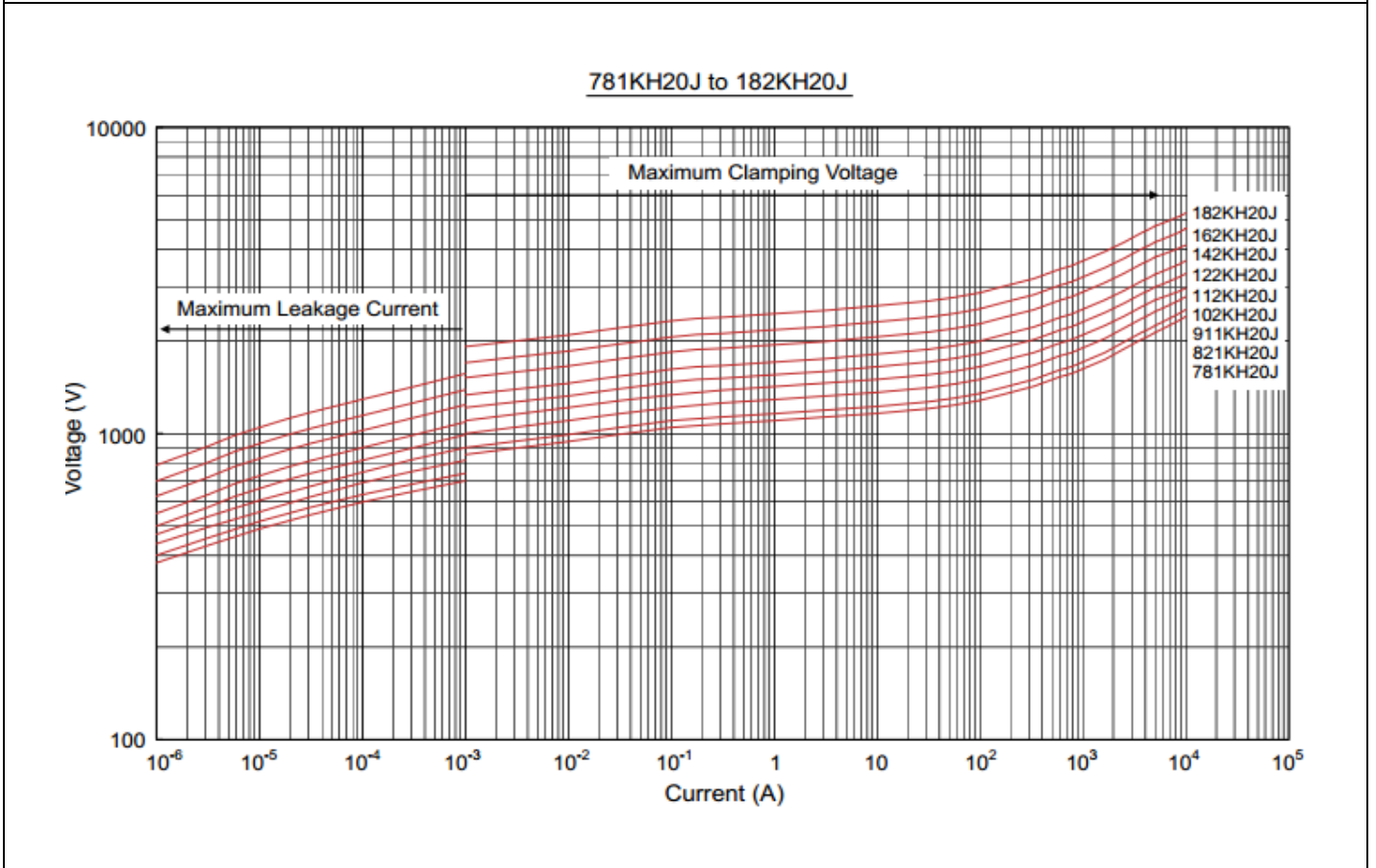
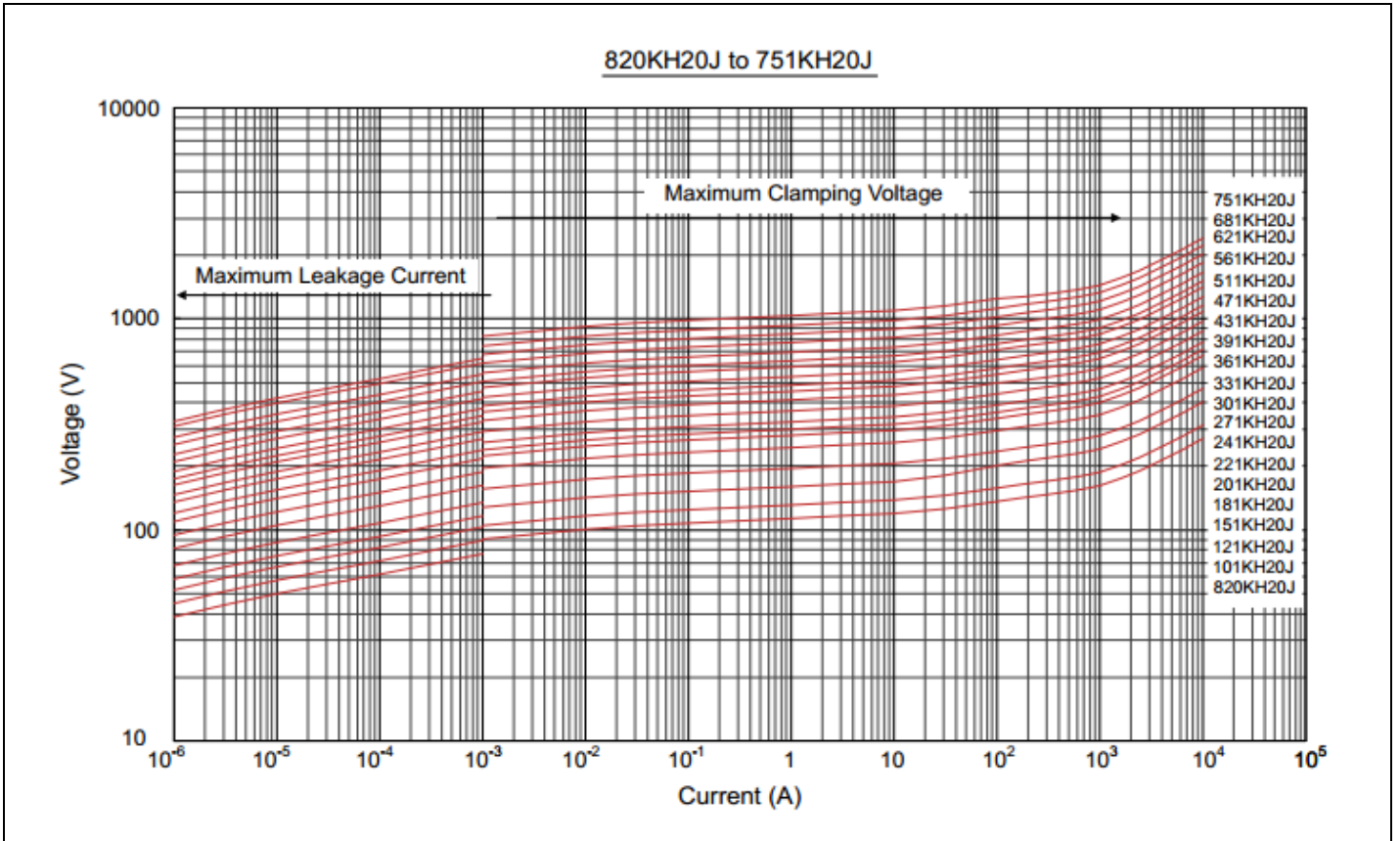

Marking Code

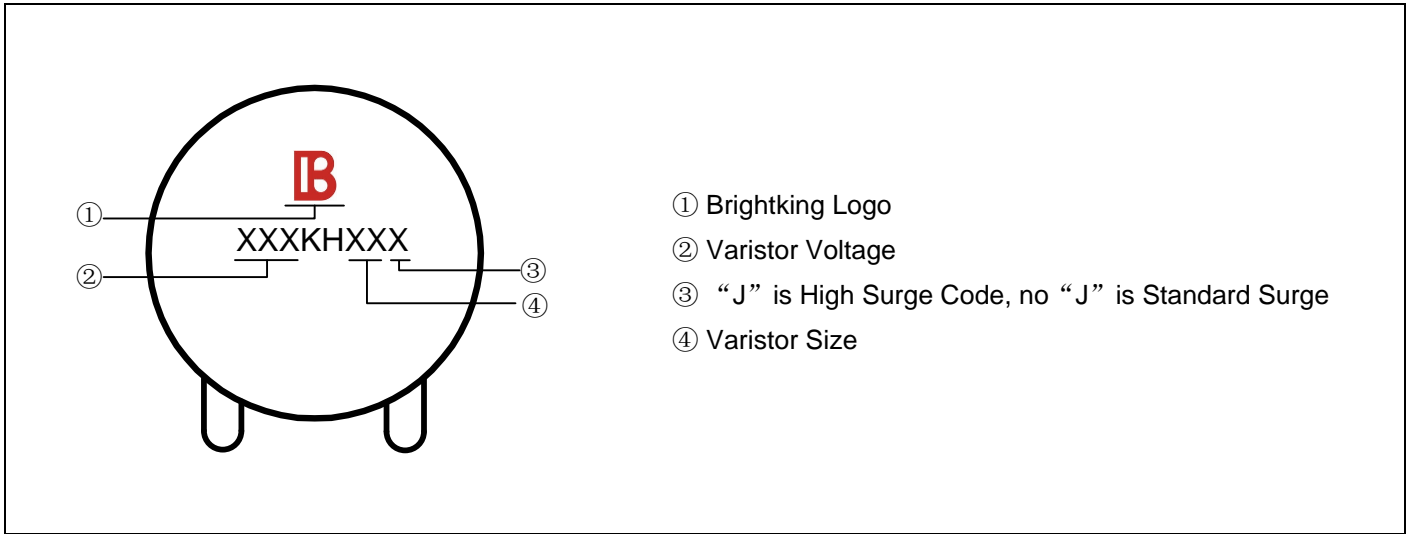

Quantity

Packaging Dimensions (Unit: mm)	Quantity
Bulk 	400pcs/ box (180K~301K)
	300pcs/ box (331K~471K)
	200pcs/ box (511K~681K)
	100pcs/ box (751K~182K)

LEGAL DISCLAIMER

YAGEO, its distributors and agents (collectively, "YAGEO"), hereby disclaims any and all liabilities for any errors, inaccuracies or incompleteness contained in any product related information, including but not limited to product specifications, datasheets, pictures and/or graphics. YAGEO may make changes, modifications and/or improvements to product related information at any time and without notice.

YAGEO makes no representation, warranty, and/or guarantee about the fitness of its products for any particular purpose or the continuing production of any of its products. To the maximum extent permitted by law, YAGEO disclaims (i) any and all liability arising out of the application or use of any YAGEO product, (ii) any and all liability, including without limitation special, consequential or incidental damages, and (iii) any and all implied warranties, including warranties of fitness for a particular purpose, non-infringement and merchantability.

YAGEO products are designed for general purpose applications under normal operation and usage conditions. Please contact YAGEO for the applications listed below which require especially high reliability for the prevention of defects which might directly cause damage to the third party's life, body or property: Aerospace equipment (artificial satellite, rocket, etc.), Atomic energy-related equipment, Aviation equipment, Disaster prevention equipment, crime prevention equipment, Electric heating apparatus, burning equipment, Highly public information network equipment, data-processing equipment, Medical devices, Military equipment, Power generation control equipment, Safety equipment, Traffic signal equipment, Transportation equipment and Undersea equipment, or for any other application or use in which the failure of YAGEO products could result in personal injury or death, or serious property damage. Particularly **YAGEO Corporation and its affiliates do not recommend the use of commercial or automotive grade products for high reliability applications or manned space flight.**

Information provided here is intended to indicate product specifications only. YAGEO reserves all the rights for revising this content without further notification, as long as products are unchanged. Any product change will be announced by PCN.