

Thyristor Surge Suppressor

Version: A1 2017-12-11

Features

- Excellent capability of absorbing transient surge
- Quick response to surge voltage (nS Level)
- Eliminates overvoltage caused by fast rising transients
- Moisture sensitivity level: Level 1
- Weight: 87mg
- Non degenerative

Exterior



SMB-F

Application Information

- xDSL

Package (Top View)



Agency Approvals

Icon	Description
RoHS	Compliance with 2011/65/EU
HF	Compliance with IEC61249-2-21:2003

Schematic Symbol



Part Number and Electrical Parameter

Part Number	I _{DRM} @ V _{DRM}		V _S ^① @ I _S		V _T @ I _T		I _H	Co ^②
	μA	V	V	mA	V	A	mA	pF
	MAX		MAX		MAX		MIN	MAX
BS3500N-C-F	5	320	400	800	4	2.2	150	35

Absolute maximum ratings measured at TA= 25°C RH = 45%-75% (unless otherwise noted).

① V_S is measured at 100KV/S

② Off-state capacitance is measured at V_{DC}=2V, V_{RMS}=1V, f=1MHz

Thyristor Surge Suppressor

Version: A1 2017-12-11

Part Numbering System

BS 3500 N C F
(1) (2) (3) (4) (5)

- (1) Bencent Semiconductor Surge Arrester
- (2) Off-state Voltage, e.g. 3500=350×10⁰=350V
- (3) Package: SMB-F
- (4) Rating Surge Voltage: 6KV (10/700μs)
- (5) Flat Feet

Mark

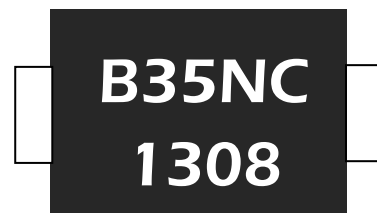

B35NC: Part Number
1308: August, 2013

V-I Curve

Parameters	Definition
V _{DRM}	Peak off-state voltage
I _{DRM}	Off-state Current
V _S	Switching Voltage
I _S	Switching Current
I _H	Holding Current
V _T	On-state voltage
I _T	On-state current
C _o	Off-state capacitance

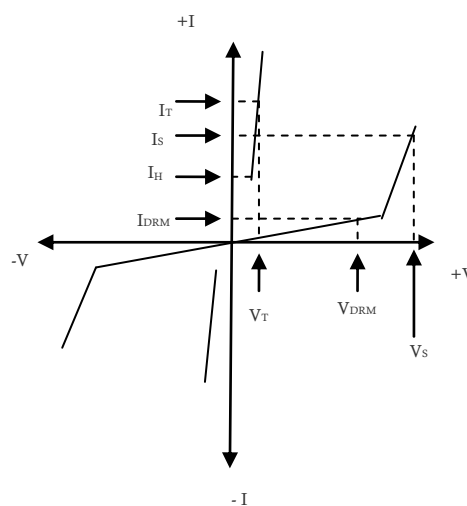

Surge Ratings

Current Waveform	2/10μs	8/20μs	10/160μs	5/320μs*	10/1000μs
Voltage Waveform	2/10μs	1.2/50μs	10/160μs	10/700μs*	10/1000μs
I _{pp}	500A	400A	200A	150A	100A

- Peak pulse current rating (I_{pp}) is repetitive and guaranteed for the life of the product;
- Bencent only makes the test for 5/320μs@150A* (10/700μs@6KV), but for other IPP value derived from experience is just for reference only. Bencent will not take any obligation for these parameters, so before applying our parts, please make sure to verify the parameters listed in the above table.

Thermal Considerations

Symbol	Parameter	Value	Unit
T _J	Operating Junction Temperature Range	-40 to +150	°C
T _S	Storage Temperature Range	-60 to +150	°C

Product Characteristics

Lead Material	Copper Alloy
Body Material	UL recognized epoxy meeting flammability classification 94V-0
Terminal Finish	100% Matte-Tin Plated

Typical Characteristics

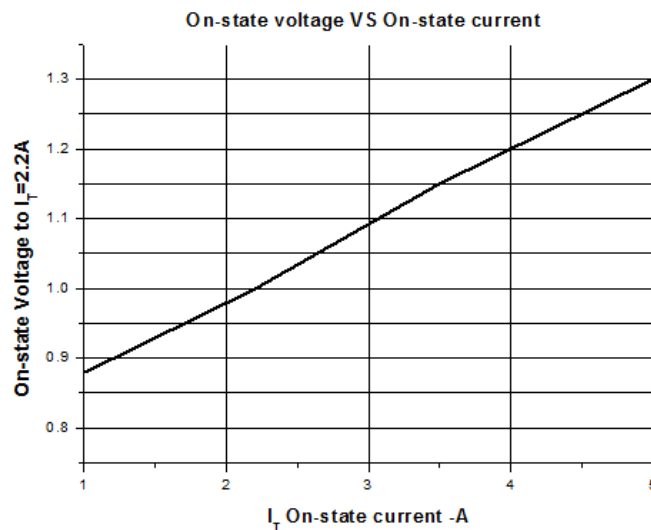
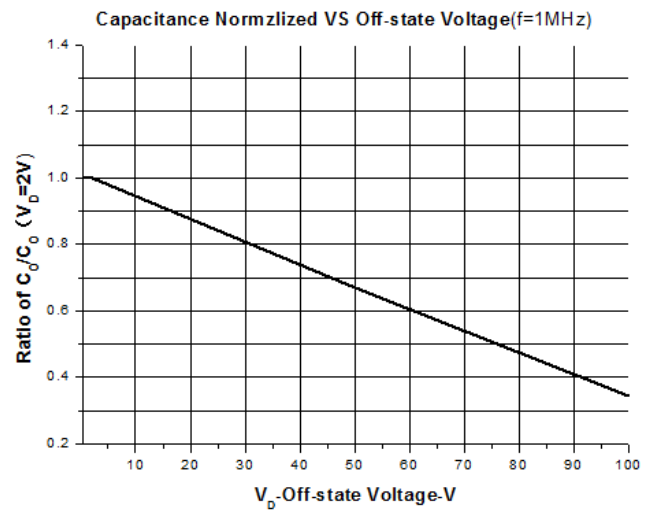
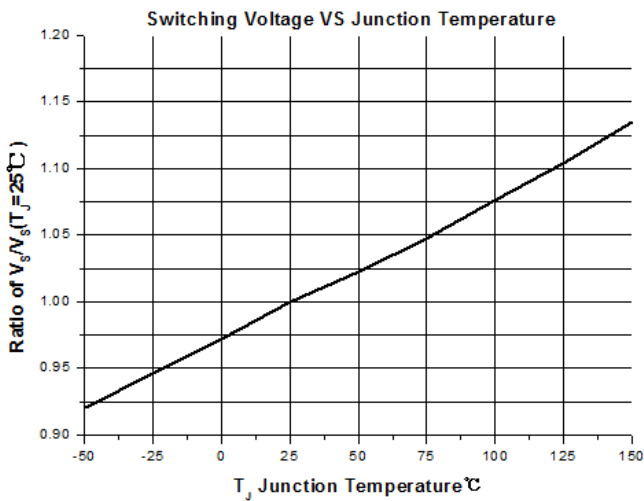
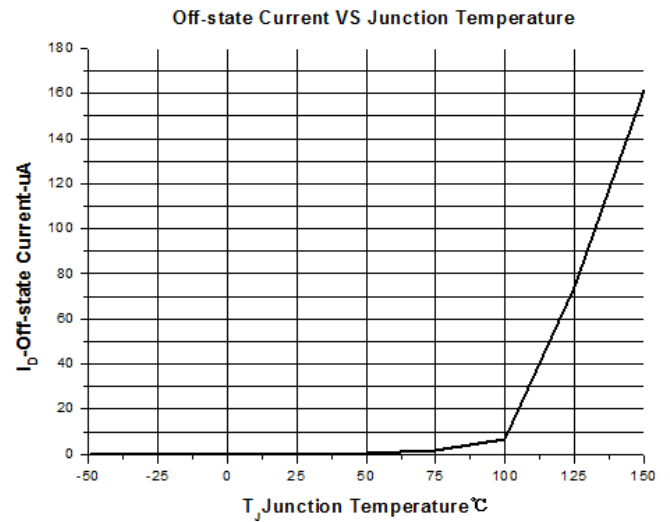
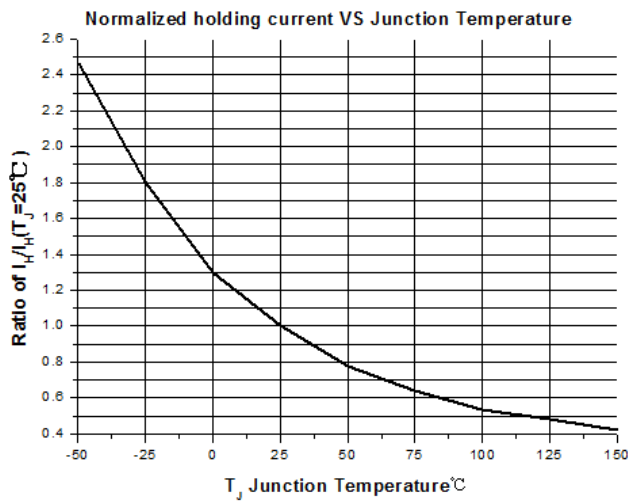

Environmental Characteristics

Testing items	Technical standards
High temperature Reverse Bias Test	Temperature: $150\pm 3^{\circ}\text{C}$, Bias= $80\%V_{\text{DRM}}$ Time: 168H
High Temperature Life Test	Temperature: 150°C Time: 168H
High-low Temperature Cycle test	Temperature: From -40°C to 125°C Dwell time: 30min, 10cycles
High Temperature & High Humidity Test	Temperature: 85°C , Humidity: 85% Test time: 168H
Pressure cooker Test	Temperature: 121°C , 2atm, Humidity: 100% Test time: 24H
Resistance of soldering heat	Temperature: $260\pm 5^{\circ}\text{C}$ Time of dip soldering: 10s, 3times

Note: The above testing items can be specified by customer's special request

Product Dimensions

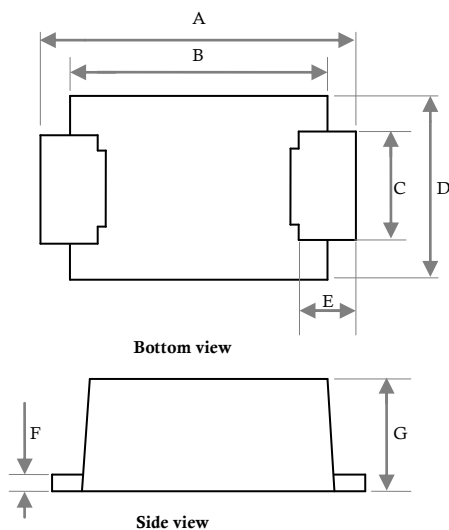

REF	mm	inch
A	5.4 ± 0.3	0.213 ± 0.012
B	4.4 ± 0.2	0.173 ± 0.008
C	2.0 ± 0.1	0.079 ± 0.004
D	3.3 ± 0.3	0.130 ± 0.012
E	0.8 ± 0.3	0.032 ± 0.012
F	0.25 ± 0.05	0.010 ± 0.002
G	2 ± 0.3	0.079 ± 0.012

Recommended Soldering Pad

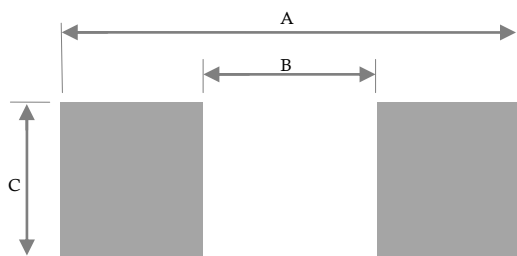

REF	mm	inch
A	6.4	0.252
B	3.4	0.134
C	2.75	0.108

Thyristor Surge Suppressor

Version: A1 2017-12-11

Reflow Profile

Reflow Condition		Pb-Free assembly
Pre Heat	Temperature Min	150°C
	Temperature Max	200°C
	Time (min to max)	60 – 180 secs
Average ramp up rate (Liquid) T _{amp} (T _L) to peak		3°C/second max
T _S (max) to T _L - Ramp-up Rate		3°C/second max
Reflow	- Temperature (T _L) (Liquid)	217°C
	- Temperature (T _L)	60 – 150 seconds
Peak Temperature (T _P)		260+0/-5 °C
Time within 5°C of actual peak Temperature (T _P)		8 – 15 seconds
Ramp-down Rate		6°C/second max
Time 25°C to peak Temperature (T _P)		8 minutes Max.
Do not exceed		260°C

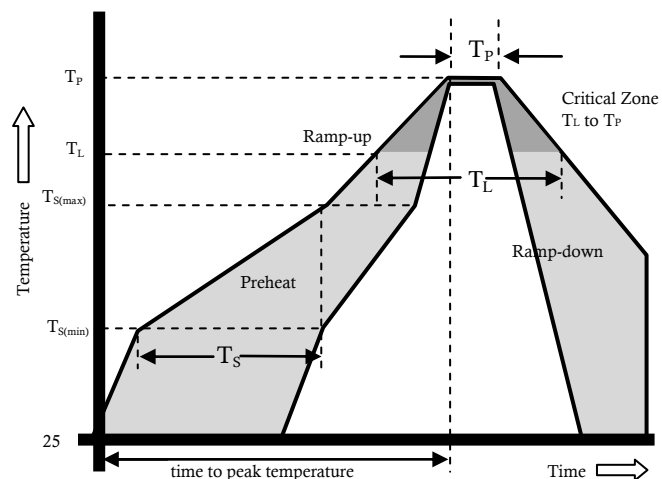

Package Reel Information

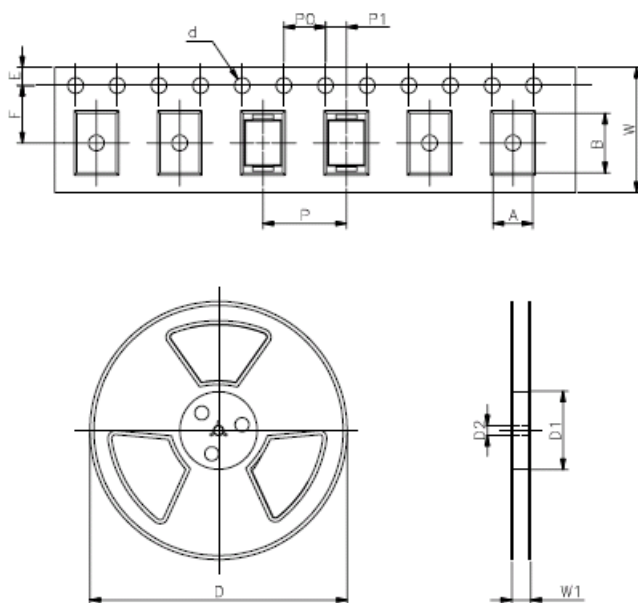

REF	mm	inch
A	3.65+/-0.3	0.144+/-0.012
B	5.69+/-0.3	0.244+/-0.012
d	1.5+/-0.1	0.059+/-0.004
D	330.0	13.0
D1	100+/-3	3.937+/-0.118
D2	13+/-0.3	0.512+/-0.012
E	1.5+/-0.2	0.059+/-0.008
F	5.65+/-0.2	0.222+/-0.008
P	8.0+/-0.2	0.315+/-0.008
P0	4.0+/-0.2	0.157+/-0.008
P1	2.0+/-0.2	0.079+/-0.008
W	12.0+/-0.2	0.472+/-0.008
W1	16.8+/-2.0	0.661+/-0.079

OUTLINE	REEL (PCS)	PER CARTON (PCS)	REEL DIAMETERS (mm)	CARTON SIZE(mm)		
				L	W	H
TAPING	3,000	48,000	330	360	360	385