

■ 绕线型片式陶瓷体电感

Wire Wound Chip Ceramic Inductors

◆ 特征 Feature

- * 体积小, 适合高密度表面贴装
Minature Size,Suitable For SMT.
- * 采用端电极结构, 很好地抑制了引线引起的寄生元件效应, 具有高可靠性
Nusing Terminal Electrode Structure To Restrain The Parasitic Component Effect Quite Caused By Lead.
- * 低电阻、高电流和高电感量
High Q Value And Tight InductanceTolerance.
- * 优良的焊接性和耐焊性
Excellent In Solderability And Heat Resistance.



◆ 应用 Application

- * 移动通信、PDA
Portable Communication Equipment And PDA.
- * 各种高频回路
High Speed Electronic Device.
- * 无线通信模块,无线局域网 W-LAN.
RF Wireless Data Communication Module,W-LAN.

◆ 型号表示法 Part Number

FHW	0805	UC	068	J	S	T
①	②	③	④	⑤	⑥	⑦

①产品类型 Product Typel:

FHW: 绕线型片式电感器系列

FHW: Wire Wound Inductor Series

②尺寸 Dimensions: 0805(2.0x1.2mm)、1008 (2.5x2.0mm)、1210 (3.2x2.5mm)

③材料代号 Material Code: UC/HC---陶瓷芯 Ceramic Core

④标称电感量 Inductance: 1N0=1.0nH、010=10nH、R10=100nH、1R0=1.0μH、100=10μH、101=100μH、102=1mH

⑤标称电感值偏差 Tolerance: G---±2%; J---±5%; K---±10%; M---±20%

⑥电极表面镀层材料 Terminal: G---金端头 Gold; S---锡端头 Tin

⑦包装 Packaging: T: 编带包装 Tape & Reel B: 散装 Bulk

◆ 产品结构 Product Structure

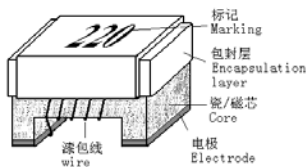

规格尺寸 Dimension

单位 Unit: mm (inch)

Size	L (Max)	W (Max)	T (Max)	A	B
2012 (0805)	2.30 (0.091)	1.70 (0.067)	1.52 (0.060)	1.27 (0.050)	0.50 (0.020)
2520 (1008)	2.92 (0.115)	2.79 (0.110)	2.10 (0.083)	2.00 (0.079)	0.50 (0.020)
3225 (1210)	3.50 (0.138)	2.90 (0.114)	2.25 (0.088)	2.10 (0.083)	0.50 (0.020)

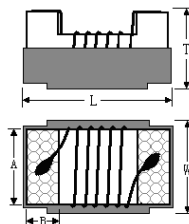
电性能参数 ELECTRICAL CHARACTERISTICS

0805 Type

型号 Part NO	电感量 Inductance (nH)	偏差范围 Tolerance	Q 值 Q (Min)	自谐振频率 SRF (MHZ) Min	最大直流电阻 Rdc (Ω) Max	额定电流 Idc(mA) Max
FHW0805UC2N2□GT	2.2@250MHz	10	50@1500MHz	8500	0.030	800
FHW0805UC2N7□GT	2.7@250MHz	10,5	50@1500MHz	8000	0.045	800
FHW0805UC3N3□GT	3.3@250MHz	10	35@1500MHz	7900	0.090	600
FHW0805UC4N7□GT	4.7@250MHz	10	40@1000MHz	6000	0.050	600
FHW0805UC5N□GT	5.6@250MHz	10,5	50@1000MHz	5500	0.065	600
FHW0805UC6N8□GT	6.8@250MHz	10,5	50@1000MHz	5500	0.110	600
FHW0805UC8N2□GT	8.2@250MHz	10,5	35@1000MHz	4700	0.200	600
FHW0805UC010□GT	10@250MHz	10,5,2	50@500MHz	4200	0.150	600
FHW0805UC012□GT	12@250MHz	10,5,2	50@500MHz	4000	0.150	600
FHW0805UC015□GT	15@250MHz	10,5,2	45@500MHz	3400	0.170	600
FHW0805UC018□GT	18@250MHz	10,5,2	55@500MHz	3300	0.200	600
FHW0805UC022□GT	22@250MHz	10,5,2	55@500MHz	2600	0.220	500
FHW0805UC027□GT	27@250MHz	10,5,2	55@500MHz	2500	0.250	500
FHW0805UC033□GT	33@250MHz	10,5,2	55@500MHz	2050	0.270	500
FHW0805UC039□GT	39@250MHz	10,5,2	55@500MHz	2000	0.290	500
FHW0805UC047□GT	47@200MHz	10,5,2	55@500MHz	1650	0.310	500
FHW0805UC056□GT	56@200MHz	10,5,2	55@500MHz	1550	0.340	500
FHW0805UC068□GT	68@200MHz	10,5,2	55@500MHz	1450	0.380	500
FHW0805UC075□GT	75@200MHz	10,5,2	55@500MHz	1400	0.400	400
FHW0805UC082□GT	82@150MHz	10,5,2	55@500MHz	1300	0.420	400
FHW0805UCR10□GT	100@150MHz	10,5,2	50@500MHz	1200	0.460	400
FHW0805UCR12□GT	120@150MHz	10,5,2	45@250MHz	1100	0.510	400
FHW0805UCR15□GT	150@100MHz	10,5,2	45@250MHz	920	0.560	400
FHW0805UCR18□GT	180@100MHz	10,5,2	45@250MHz	870	0.640	400
FHW0805UCR22□GT	220@100MHz	10,5,2	40@250MHz	850	1.050	400
FHW0805UCR27□GT	270@100MHz	10,5,2	40@250MHz	650	1.100	350
FHW0805UCR33□GT	330@100MHz	10,5	40@250MHz	600	1.400	310
FHW0805UCR39□GT	390@100MHz	10,5	40@250MHz	560	1.500	290
FHW0805UCR47□GT	470@50MHz	10,5	33@100MHz	375	2.000	250

FHW0805UCR56□GT	560@25MHz	10,5	23@50MHz	340	1.900	230
FHW0805UCR68□GT	680@25MHz	10,5	23@50MHz	300	2.100	190
FHW0805UCR75□GT	750@25MHz	10,5	23@50MHz	280	2.120	180
FHW0805UCR82□GT	820@25MHz	10,5	23@50MHz	250	2.140	180
FHW0805UCR91□GT	910@25MHz	10,5	20@50MHz	220	2.280	180
FHW0805UC1R0□GT	1000@25MHz	10,5	20@50MHz	200	2.400	170
FHW0805UC1R2□GT	1200@7.9MHz	10,5	18@50MHz	180	2.550	170
FHW0805UC1R5□GT	1500@7.9MHz	10,5	18@50MHz	170	2.800	160
FHW0805UC1R8□GT	1800@7.9MHz	10,5	18@50MHz	140	3.800	150
FHW0805UC2R2□GT	2200@7.9MHz	10,5	16@7.9MHz	50	4.200	150

1008Type

型号 Part NO	电感量 Inductance (nH)	偏差范围 Tolerance	Q 值 Q (Min)	自谐振频率 SRF (MHZ) Min	最大直流电阻 Rdc (Ω) Max	额定电流 Idc(mA) Max
FHW1008UC3N9□GT	3.9@50MHz	10,5	50@1500MHz	6000	0.035	1000
FHW1008UC4N7□GT	4.7@50MHz	10,5	50@1500MHz	6000	0.045	1000
FHW1008UC5N6□GT	5.6@50MHz	10,5	30@1000MHz	6000	0.180	1000
FHW1008UC8N2□GT	8.2 @50MHz	10,5	50@1000MHz	5000	0.050	1000
FHW1008UC010□GT	10@50MHz	10,5,2	50@500MHz	4100	0.080	1000
FHW1008UC012□GT	12@50MHz	10,5,2	50@500MHz	3300	0.090	1000
FHW1008UC015□GT	15@50MHz	10,5,2	45@500MHz	2500	0.150	1000
FHW1008UC018□GT	18@50MHz	10,5,2	50@350MHz	2500	0.110	1000
FHW1008UC022□GT	22@50MHz	10,5,2	55@350MHz	2400	0.120	1000
FHW1008UC027□GT	27@50MHz	10,5,2	55@350MHz	1600	0.130	1000
FHW1008UC033□GT	33@50MHz	10,5,2	60@350MHz	1600	0.140	1000
FHW1008UC039□GT	39@50MHz	10,5,2	60@350MHz	1500	0.150	1000
FHW1008UC047□GT	47@50MHz	10,5,2	65@350MHz	1500	0.160	1000
FHW1008UC056□GT	56@50MHz	10,5,2	65@350MHz	1100	0.180	1000
FHW1008UC068□GT	68@50MHz	10,5,2	65@350MHz	1000	0.200	1000
FHW1008UC082□GT	82@50MHz	10,5,2	60@350MHz	1000	0.220	1000
FHW1008UCR10□GT	100@25MHz	10,5,2	60@350MHz	1000	0.560	650
FHW1008UCR12□GT	120@25MHz	10,5,2	60@350MHz	950	0.630	650
FHW1008UCR15□GT	150@25MHz	10,5,2	45@100MHz	800	0.700	580
FHW1008UCR18□GT	180@25MHz	10,5,2	45@100MHz	640	0.770	620
FHW1008UCR22□GT	220@25MHz	10,5,2	45@100MHz	620	0.840	500
FHW1008UCR27□GT	270@25MHz	10,5,2	45@100MHz	600	0.910	500
FHW1008UCR33□GT	330@25MHz	10,5,2	45@100MHz	500	1.050	450
FHW1008UCR39□GT	390@25MHz	10,5,2	45@100MHz	480	1.120	470
FHW1008UCR47□GT	470@25MHz	10,5,2	45@100MHz	450	1.190	470
FHW1008UCR56□GT	560@25MHz	10,5,2	45@100MHz	415	1.330	400
FHW1008UCR68□GT	680@25MHz	10,5,2	45@100MHz	375	1.470	400
FHW1008UCR82□GT	820@25MHz	10,5	45@100MHz	250	1.610	400

FHW1008UC1R0□GT	1000@25MHz	10,5	35@50MHz	210	1.750	370
FHW1008UC1R2□GT	1200@7.9MHz	10,5	35@50MHz	200	2.000	310
FHW1008UC1R5□GT	1500@7.9MHz	10,5	28@50MHz	180	2.300	330
FHW1008UC1R8□GT	1800@7.9MHz	10,5	28@50MHz	160	2.600	300
FHW1008UC2R2□GT	2200@7.9MHz	10,5	20@50MHz	90	2.800	280
FHW1008UC2R7□GT	2700@7.9MHz	10,5	22@25MHz	80	3.200	290
FHW1008UC3R3□GT	3300@7.9MHz	10,5	22@25MHz	70	3.400	290
FHW1008UC3R9□GT	3900@7.9MHz	10,5	16@25MHz	60	3.600	260
FHW1008UC4R7□GT	4700@7.9MHz	10,5	18@25MHz	60	4.000	260
FHW1008UC5R6□GT	5600@7.9MHz	10,5	18@7.9MHz	55	7.600	240
FHW1008UC6R8□GT	6800@7.9MHz	10,5	18@7.9MHz	50	8.200	200
FHW1008UC8R2□GT	8200@7.9MHz	10,5	18@7.9MHz	40	8.200	170
FHW1008UC100□GT	10000@7.9MHz	10,5	20@7.9MHz	40	9.100	160

1210 Type

型号 Part NO	电感量 Inductance (nH)	偏差范围 Tolerance	Q 值 Q (Min)	自谐振频率 SRF (MHZ) Min	最大直流电阻 Rdc (Ω) Max	额定电流 Idc(mA) Max
FHW1210HC3N9□GT	3.9@100MHz	10	30@300MHz	6000	0.050	1000
FHW1210HC4N7□GT	4.7@100MHz	10,5	30@300MHz	5800	0.065	1000
FHW1210HC8N2□GT	8.2@100MHz	10	30@300MHz	5500	0.070	1000
FHW1210HC010□GT	10@100MHz	10,5,2	40@300MHz	4000	0.080	1000
FHW1210HC012□GT	12@100MHz	10,5	40@300MHz	3200	0.080	1000
FHW1210HC015□GT	15@100MHz	10,5	40@300MHz	3200	0.100	1000
FHW1210HC018□GT	18@100MHz	10,5,2	50@300MHz	2800	0.100	1000
FHW1210HC022□GT	22@100MHz	10,5	50@300MHz	2000	0.100	1000
FHW1210HC027□GT	27@100MHz	10,5,2	50@300MHz	1800	0.110	1000
FHW1210HC033□GT	33@100MHz	10,5,2	55@300MHz	1800	0.110	1000
FHW1210HC039□GT	39@100MHz	10,5,2	55@300MHz	1800	0.120	1000
FHW1210HC047□GT	47@100MHz	10,5,2	55@300MHz	1500	0.130	1000
FHW1210HC056□GT	56@100MHz	10,5,2	55@300MHz	1450	0.140	1000
FHW1210HC068□GT	68@100MHz	10,5,2	55@300MHz	1200	0.150	900
FHW1210HC082□GT	82@100MHz	10,5,2	55@300MHz	1000	0.200	900
FHW1210HCR10□GT	100@100MHz	10,5,2	55@300MHz	900	0.210	850
FHW1210HCR12□GT	120@100MHz	10,5,2	60@300MHz	800	0.210	800
FHW1210HCR15□GT	150@100MHz	10,5,2	60@300MHz	780	0.250	750
FHW1210HCR18□GT	180@50MHz	10,5,2	60@300MHz	760	0.300	700
FHW1210HCR22□GT	220@50MHz	10,5,2	60@300MHz	650	0.320	670
FHW1210HCR27□GT	270@50MHz	10,5,2	55@300MHz	620	0.340	630
FHW1210HCR33□GT	330@50MHz	10,5,2	45@150MHz	600	0.380	590
FHW1210HCR39□GT	390@50MHz	10,5,2	45@150MHz	510	0.580	530
FHW1210HCR47□GT	470@50MHz	10,5,2	45@150MHz	500	0.800	490
FHW1210HCR56□GT	560@35MHz	10,5	45@150MHz	420	1.100	460

FHW1210HCR68□GT	680@35MHz	10,5,2	45@150MHz	400	1.200	430
FHW1210HCR75□GT	750@35MHz	10,5,2	45@150MHz	380	1.700	400
FHW1210HCR82□GT	820@35MHz	10,5,2	45@150MHz	370	1.820	400
FHW1210HC1R0□GT	1000@35MHz	10,5,2	45@150MHz	340	1.850	320
FHW1210HC1R2□GT	1200@35MHz	10,5	35@150MHz	220	1.870	300
FHW1210HC1R5□GT	1500@7.9MHz	10,5	30@50MHz	160	1.950	310
FHW1210HC1R8□GT	1800@7.9MHz	10,5	30@50MHz	160	2.250	310
FHW1210HC2R2□GT	2200@7.9MHz	10,5	30@50MHz	110	2.410	310
FHW1210HC2R7□GT	2700@7.9MHz	10,5	25@25MHz	100	2.850	300
FHW1210HC3R3□GT	3300@7.9MHz	10,5	20@25MHz	85	3.120	300
FHW1210HC3R9□GT	3900@7.9MHz	10,5	20@25MHz	80	3.600	290
FHW1210HC4R7□GT	4700@7.9MHz	10,5	16@25MHz	60	4.000	280
FHW1210HC5R6□GT	5600@7.9MHz	10,5	20@7.9MHz	60	5.000	250
FHW1210HC6R8□GT	6800@7.9MHz	10,5	20@7.9MHz	55	8.000	230
FHW1210HC8R2□GT	8200@7.9MHz	10,5	20@7.9MHz	50	8.600	170
FHW1210HC100□GT	10000@7.9MHz	10,5	22@7.9MHz	20	6.800	200

◆可靠性测试方法 Reliability Test Method

序号 No.	项目 Items	要求 Requirements	试验方法及备注 Test Methods and Remarks								
1	可焊性 Solder ability	①外观无可见损伤痕迹; No visible mechanical damage. ②端电极表面焊锡覆盖率。 Electrode surface solder coverage. FHW-UC/HC series: $\geq 90\%$ 。	在 $245\pm 3^{\circ}\text{C}$ 熔融的焊锡 (96.5%Sn/3.0%Ag/0.5%Cu) 中浸置 $3\pm 0.3\text{s}$ 。 Dip pads in flux and dip in solder pot(96.5Sn/3.0Ag/0.5Cu)at $245\pm 3^{\circ}\text{C}$ for $3\pm 0.3\text{s}$.								
2	耐焊接热 Resistance to Soldering	①外观无可见损伤痕迹; No visible mechanical damage. ②感量变化不超过 $\pm 5\%$; Inductance shall not change more than $\pm 5\%$; ③Q 值变化不超过 $\pm 10\%$ 。 Q shall not change more than $\pm 10\%$ 。	在 $260\pm 5^{\circ}\text{C}$ 熔融的焊锡 (96.5%Sn/3.0%Ag/0.5%Cu) 中浸置 $10\pm 1\text{s}$ 。 Dip pads in flux and dip in solder pot(96.5Sn/3.0Ag/0.5Cu)at $260\pm 5^{\circ}\text{C}$ for $10\pm 1\text{s}$.								
3	振动 Vibration	①外观无可见损伤痕迹; No visible mechanical damage. ②感量变化不超过 $\pm 5\%$; Inductance shall not change more than $\pm 5\%$; ③Q 值变化不超过 $\pm 10\%$ 。 Q shall not change more than $\pm 10\%$ 。	振幅 1.5mm, 频率 10~55Hz, 每个方向(X、Y、Z)保持 2 小时。Inductors shall be subjected to vibration of 1.5mm amplitude frequency 10~55Hz (10Hz to 55Hz to 10Hz in a period of 1 minute) for 2h in each of three(X、Y、Z) axes.								
4	端电极强度 Adhesion of electrode	①试验后端电极无脱落; The end electrode did not fall off after the test. ②外观无可见损伤痕迹。 No visible mechanical damage.	将产品焊在 PCB 板上, 按下图、表所示方向及要求施加作用力。Weld the product on the PCB board, and apply force as shown in the diagram, direction and requirement.  <table border="1" data-bbox="986 1619 1455 1832"> <thead> <tr> <th>尺寸规格 Size</th> <th>施加力要求</th> </tr> </thead> <tbody> <tr> <td>0805UC And Above Series.</td> <td>20 N</td> </tr> <tr> <td colspan="2">Keep time: (10\pm1)s</td> </tr> <tr> <td colspan="2">Speed: 1.0 mm/s.</td> </tr> </tbody> </table>	尺寸规格 Size	施加力要求	0805UC And Above Series.	20 N	Keep time: (10 \pm 1)s		Speed: 1.0 mm/s.	
尺寸规格 Size	施加力要求										
0805UC And Above Series.	20 N										
Keep time: (10 \pm 1)s											
Speed: 1.0 mm/s.											

5	耐低温 Low temperature resistance	①外观无可见损伤痕迹; No visible mechanical damage. ②感量变化不超过±5%; Inductance shall not change more than ±5%; ③Q 值变化不超过±10%。 Q shall not change more than±10%.	①FHW-UC/HC 系列产品放置于温度-55±2℃的环境中存放 1000 —0 h +24 FHW-UC/HC series shall be subjected to-55±2℃ for 1000 +24 —0 h
6	耐高温 High temperature resistance	①外观无可见损伤痕迹; No visible mechanical damage. ②感量变化不超过±5%; Inductance shall not change more than ±5%; ③Q 值变化不超过±10%。 Q shall not change more than±10%.	①FHW-UC/HC 系列产品放置于温度+125±5℃的环境中存放 1000 —0 h +24 FHW-UC/HC series shall be subjected to +125±5℃ for1000 —0 h
7	温度冲击 Temperature Shock	①外观无可见损伤痕迹; No visible mechanical damage. ②感量变化不超过±5%; Inductance shall not change more than ±5%; ③Q 值变化不超过±10%。 Q shall not change more than±10%.	①FHW-UC/HC 系列: +125℃ 30 分钟 ↔ -40℃ 30 分钟, 循环 100 次; FHW-UC/HC series : +125℃ 30minutes ↔ -40℃ 30minutes 100 Cycles.
8	高温负载 High temperature load	①外观无可见损伤痕迹; No visible mechanical damage. ②感量变化不超过±5%; Inductance shall not change more than ±5%; ③Q 值变化不超过±10%。 Q shall not change more than±10%.	①FHW-UC/HC 系列产品加额定电流在 125±2℃温度条件下存放 1000 —0 h +24 FHW-UC/HC series shall be store at 125±2℃ for 1000 +24 —0 h with rated current applied.
9	恒定湿热 Static Humidity	①外观无可见损伤痕迹; No visible mechanical damage. ②感量变化不超过±5%; Inductance shall not change more than ±5%; ③Q 值变化不超过±10%。 Q shall not change more than±10%.	将电感器放置于湿度 90%~95%,温度 60±2℃的环境中存放 1000 —0 h +24 Inductors shall be subjected to 90%~95%RH. at 60±2℃ for 1000 —0 h
10	抗弯强度 Bending strength	外观无可见损伤痕迹; No visible mechanical damage.	①将电感器安装于试验基板上; 在垂直方向施加力(如下图所示)。Install the inductor on the test substrate; Apply force in the vertical direction (as shown below). ②该板应在(1±0.5) mm/s 的弯曲速率向下弯曲(2±0.2) mm, 保持时间(20±1) s。The epoxy plate should bend down to (2±0.2) mm at the bending rate of (1±0.5)

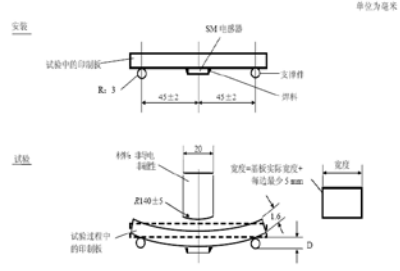
			<p>mm/s, Keep time (20±1) sec.</p> 
11	耐溶剂性 Solvent Resistance	<p>①外观无可见损伤痕迹; No visible mechanical damage.</p> <p>②感量变化不超过±5%; Inductance shall not change more than ±5%;</p> <p>③Q 值变化不超过±10%. Q shall not change more than±10%.</p>	<p>将元件浸泡在 23±5°C 的异丙醇溶液中, 保持 5±0.5 分钟。 Soak in the element 23±5°C in isopropyl alcohol solution, keep 5±0.5 min.</p>

◆产品特性曲线图 Product Characteristic Curve

FHW0805 Type.

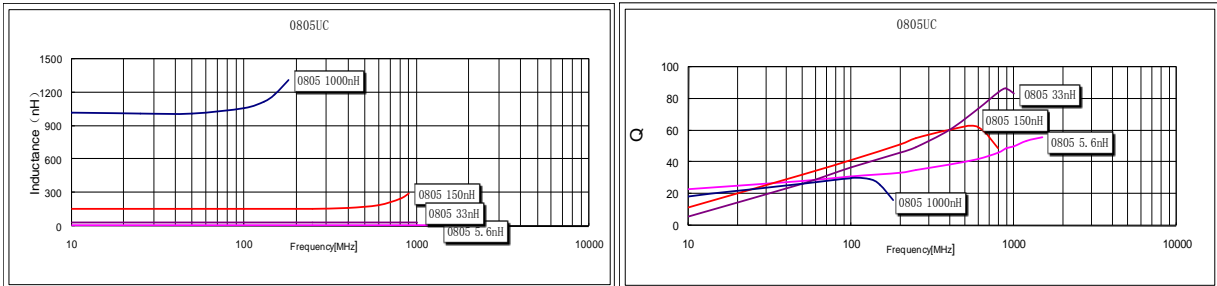

FHW1008 Type.

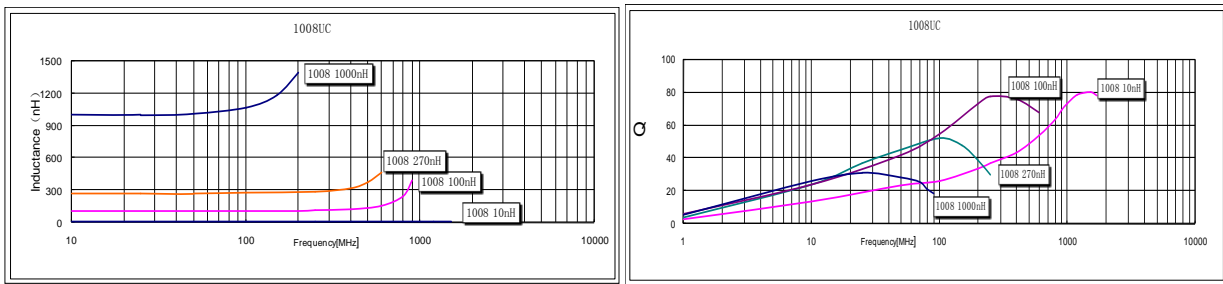

FHW1210 Type.

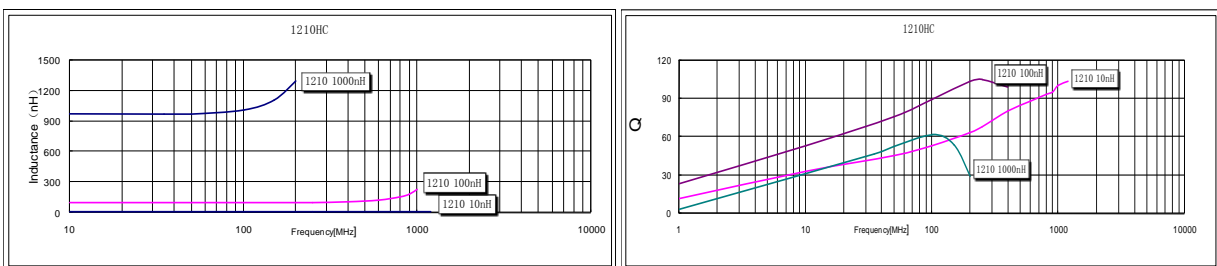

◆包装 Packaging

*编带图 Taping drawings

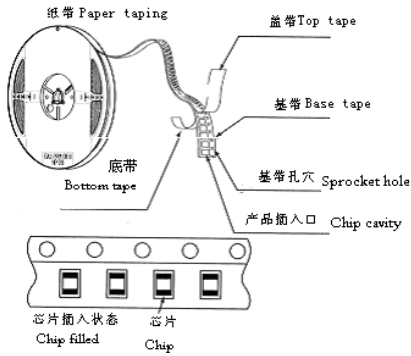

*卷盘尺寸 Reel dimensions (Unit:mm)

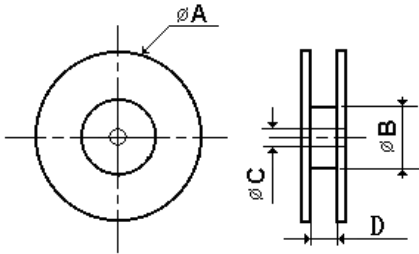

Part NO.	ΦA typ.	ΦB typ.	ΦC typ.	D typ.
0805-1210	178	60	13	8.4

*导带及空格部分 Leader and blank portion

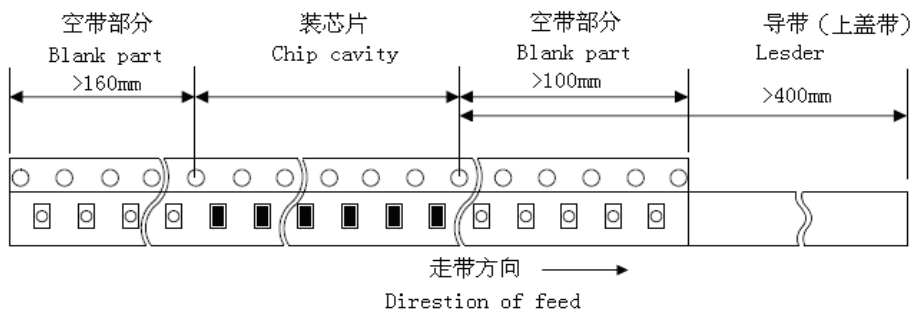

*编带尺寸 Taping dimensions (Unit: mm)

塑料胶带 EMBOSED tape

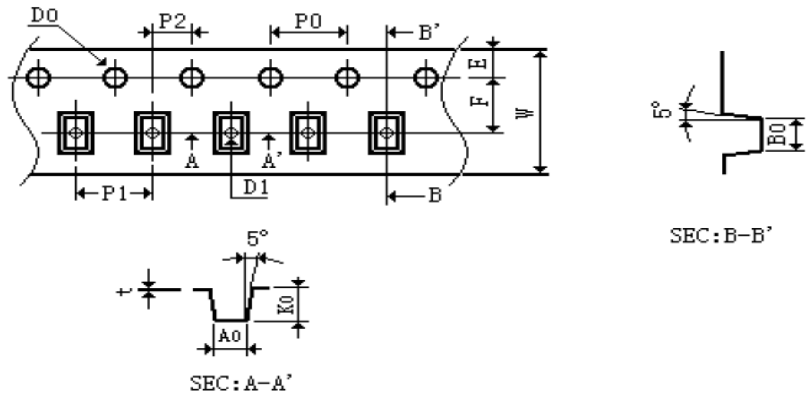

Part NO.	W	E	F	D0	D1	P0	P1	P2	P0×10	t	A0	B0	K0
0805	8.00	1.75	3.50	1.55	0.65	4	4	2	40	0.23	1.85	2.45	1.50
1008	8.00	1.75	3.50	1.55	0.65	4	4	2	40	0.25	2.73	2.90	2.34
1210	8.00	1.75	3.50	1.55	0.65	4	4	2	40	0.23	2.96	3.60	2.40

*包装数量 (单位: 粒) Packaging number (Unit: Pcs)

类型 Size		0805	1008	1210
每卷数量 Per Reel		3000	2000	2000
每盒数量 Per Box	3 卷盒	6000	6000	15000
	5 卷盒	10000	10000	25000
每箱数量 Per Case	1.5 盒箱	30000	30000	75000
	2 盒箱	40000	40000	100000
	3 盒箱	60000	60000	150000
	4 盒箱	80000	80000	200000
	6 盒箱	120000	120000	300000