

NCE N-Channel Super Trench Power MOSFET

Description

The NCEP40T11G uses **Super Trench** technology that is uniquely optimized to provide the most efficient high frequency switching performance. Both conduction and switching power losses are minimized due to an extremely low combination of $R_{DS(on)}$ and Q_g . This device is ideal for high-frequency switching and synchronous rectification.

General Features

- $V_{DS} = 40V, I_D = 110A$
 $R_{DS(on)} = 2.2m\Omega$ (typical) @ $V_{GS} = 10V$
 $R_{DS(on)} = 3.3m\Omega$ (typical) @ $V_{GS} = 4.5V$
- Excellent gate charge x $R_{DS(on)}$ product(FOM)
- Very low on-resistance $R_{DS(on)}$
- 150 °C operating temperature
- Pb-free lead plating
- 100% UIS tested

Application

- DC/DC Converter
- Ideal for high-frequency switching and synchronous rectification

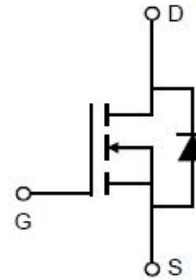

Schematic Diagram

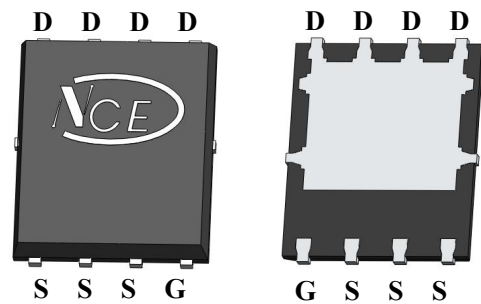

Top View

Bottom View

100% UIS TESTED!

100% ΔVds TESTED!

Package Marking and Ordering Information

Device Marking	Device	Device Package	Reel Size	Tape width	Quantity
P40T11G	NCEP40T11G	DFN5X6-8L	-	-	-

Absolute Maximum Ratings (T_c=25°C unless otherwise noted)

Parameter	Symbol	Limit	Unit
Drain-Source Voltage	V_{DS}	40	V
Gate-Source Voltage	V_{GS}	±20	V
Drain Current-Continuous	I_D	110	A
Drain Current-Continuous(T _c =100°C)	$I_D(100^\circ C)$	77.8	A
Pulsed Drain Current	I_{DM}	440	A
Maximum Power Dissipation	P_D	100	W
Derating factor		0.8	W/°C
Single pulse avalanche energy (Note 1)	E_{AS}	500	mJ
Operating Junction and Storage Temperature Range	T_J, T_{STG}	-55 To 150	°C

Thermal Characteristic

Thermal Resistance, Junction-to-Case	$R_{\theta JC}$	1.25	$^{\circ}C/W$
--------------------------------------	-----------------	------	---------------

Electrical Characteristics ($T_C=25^{\circ}C$ unless otherwise noted)

Parameter	Symbol	Condition	Min	Typ	Max	Unit
Off Characteristics						
Drain-Source Breakdown Voltage	BV_{DSS}	$V_{GS}=0V, I_D=250\mu A$	40		-	V
Zero Gate Voltage Drain Current	I_{DSS}	$V_{DS}=40V, V_{GS}=0V$	-	-	1	μA
Gate-Body Leakage Current	I_{GSS}	$V_{GS}=\pm 20V, V_{DS}=0V$	-	-	± 100	nA
On Characteristics						
Gate Threshold Voltage	$V_{GS(th)}$	$V_{DS}=V_{GS}, I_D=250\mu A$	1.2	1.7	2.2	V
Drain-Source On-State Resistance	$R_{DS(on)}$	$V_{GS}=10V, I_D=55A$	-	2.2	2.8	m Ω
		$V_{GS}=4.5V, I_D=55A$	-	3.3	4.0	m Ω
Forward Transconductance	g_{FS}	$V_{DS}=5V, I_D=55A$	-	60	-	S
Dynamic Characteristics						
Input Capacitance	C_{iss}	$V_{DS}=20V, V_{GS}=0V,$ $F=1.0MHz$	-	3510	-	PF
Output Capacitance	C_{oss}		-	860	-	PF
Reverse Transfer Capacitance	C_{rss}		-	60	-	PF
Gate resistance	R_G	$F=1.0MHz$	-	2.5	-	Ω
Switching Characteristics (Note 2)						
Turn-on Delay Time	$t_{d(on)}$	$V_{DD}=20V, I_D=55A$ $V_{GS}=10V, R_G=1.6\Omega$	-	10.5	-	nS
Turn-on Rise Time	t_r		-	4	-	nS
Turn-Off Delay Time	$t_{d(off)}$		-	35	-	nS
Turn-Off Fall Time	t_f		-	5	-	nS
Total Gate Charge	Q_g	$V_{DS}=20V, I_D=55A,$ $V_{GS}=10V$	-	60	-	nC
Gate-Source Charge	Q_{gs}		-	9.9	-	nC
Gate-Drain Charge	Q_{gd}		-	9.5	-	nC
Drain-Source Diode Characteristics						
Diode Forward Voltage	V_{SD}	$V_{GS}=0V, I_S=55A$	-		1.2	V
Diode Forward Current	I_S		-	-	110	A
Reverse Recovery Time	t_{rr}	$T_J = 25^{\circ}C, I_F = I_S$	-		24	nS
Reverse Recovery Charge	Q_{rr}	$di/dt = 100A/\mu s$	-		68	nC

Notes:

1. EAS condition : $T_J=25^{\circ}C, V_{DD}=20V, V_G=10V, L=0.5mH, R_G=25\Omega$.
2. Guaranteed by design, not subject to production
3. These curves are based on the junction-to-case thermal impedance which is measured with the device mounted to a large heatsink, assuming a maximum junction temperature of $T_J(MAX)=150^{\circ}C$. The SOA curve provides a single pulse rating.

Typical Electrical and Thermal Characteristics

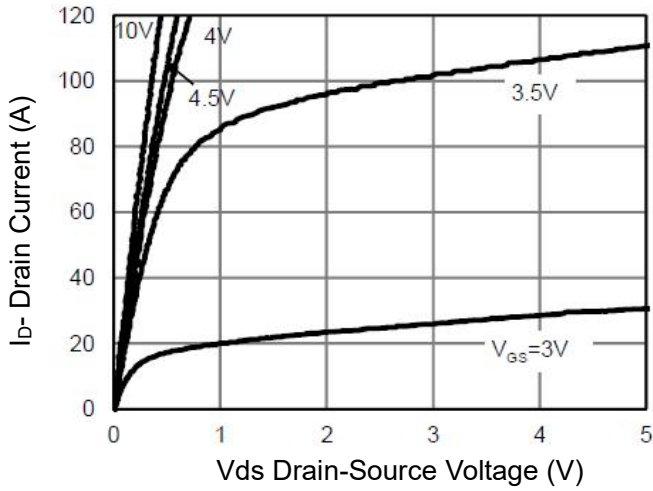

Figure 1 Output Characteristics

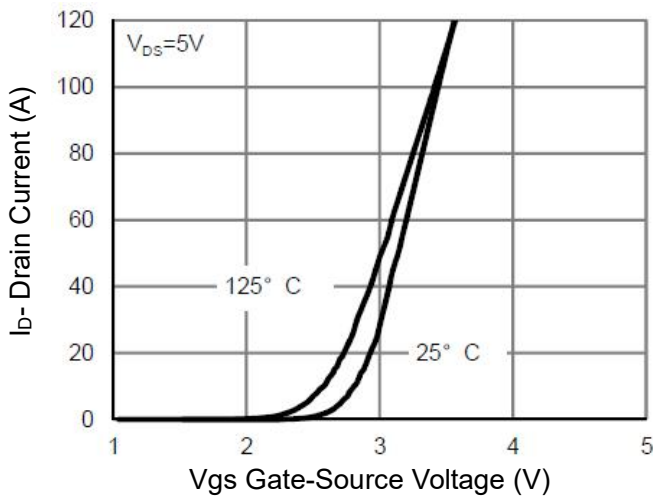

Figure 2 Transfer Characteristics

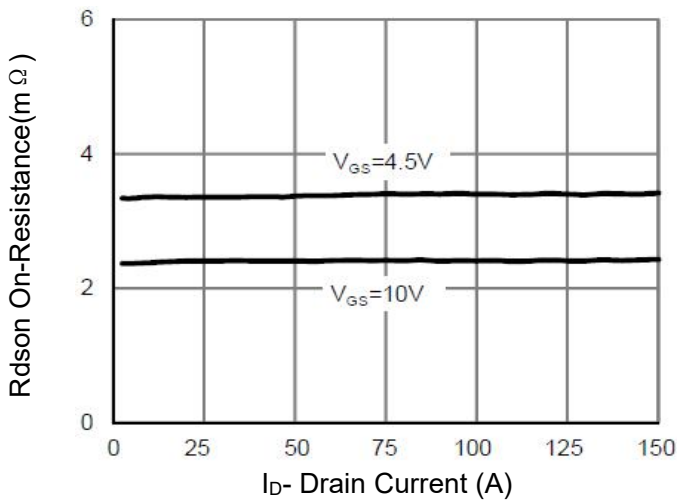

Figure 3 Rdson- Drain Current

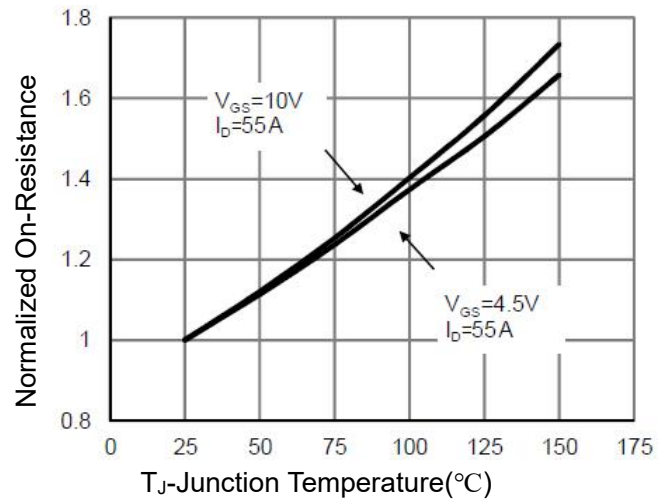

Figure 4 Rdson-Junction Temperature

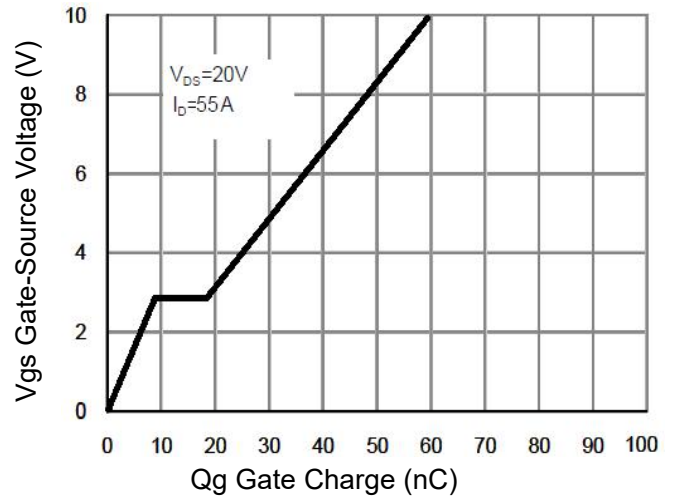

Figure 5 Gate Charge

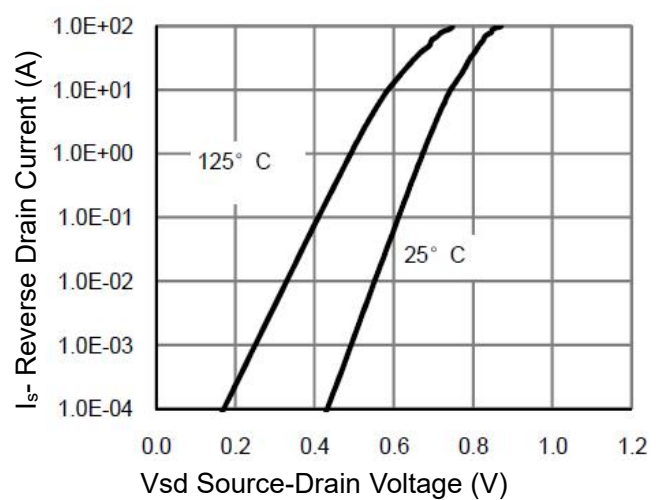

Figure 6 Source- Drain Diode Forward

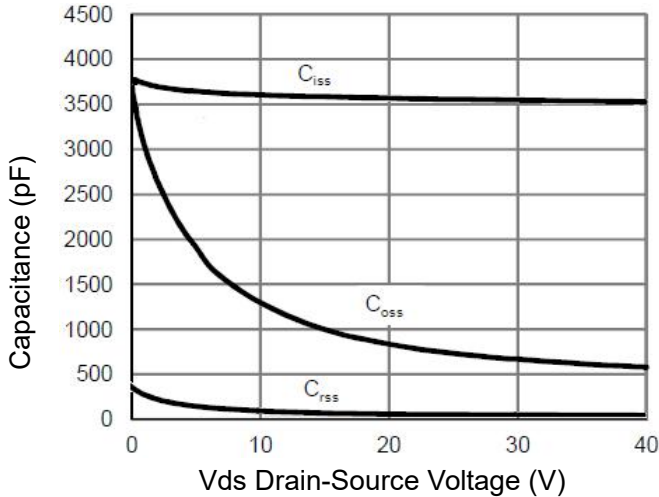

Figure 7 Capacitance vs Vds

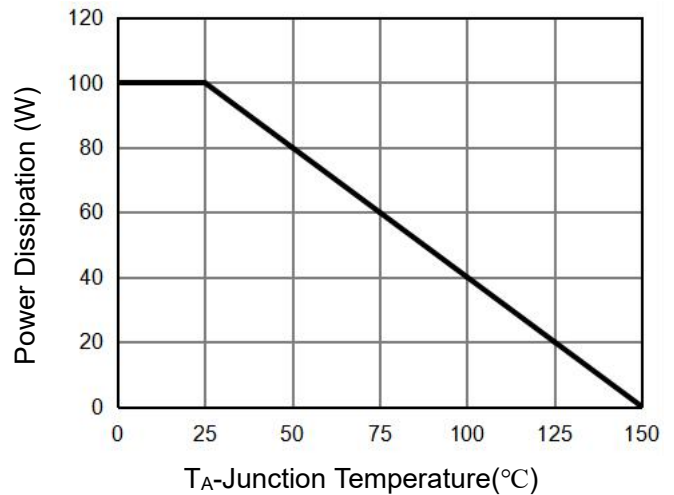

Figure 9 Power De-rating

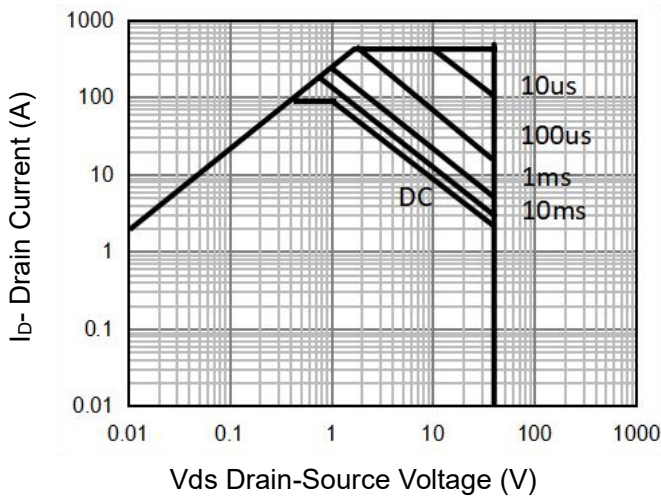

Figure 8 Safe Operation Area (Note 3)

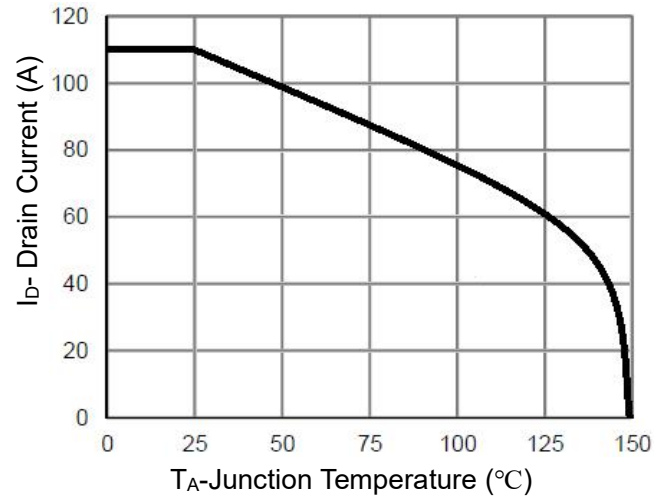

Figure 10 Current De-rating

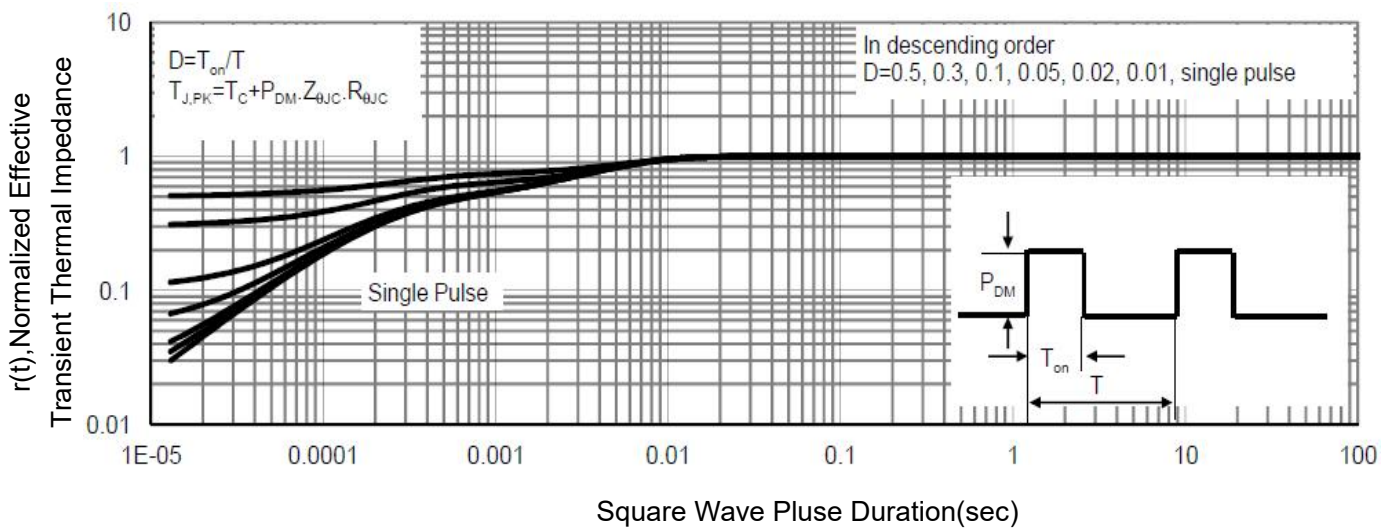
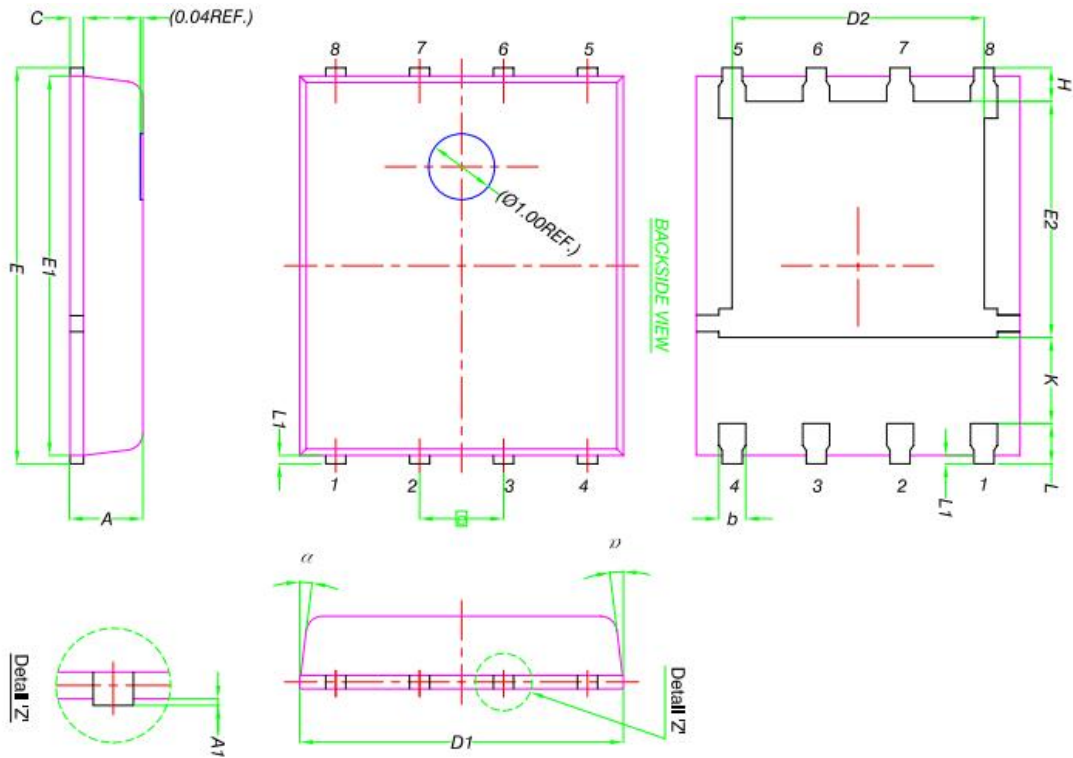
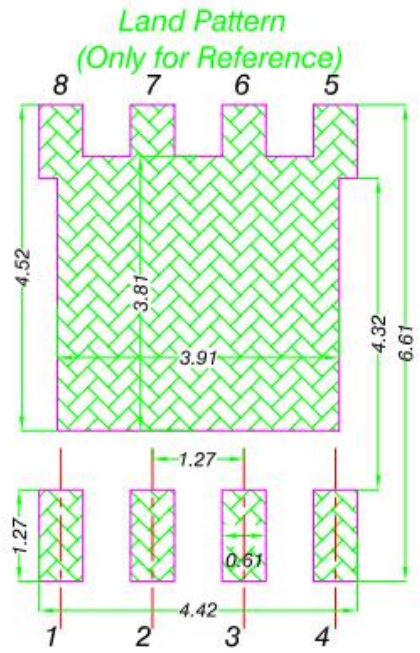

Figure 11 Normalized Maximum Transient Thermal Impedance

DFN5X6-8L(G) Package Information



DIM.	MILLIMETERS		
	MIN.	NOM.	MAX.
A	0.90	1.00	1.10
A1	0	-	0.05
b	0.33	0.41	0.51
C	0.20	0.25	0.30
D1	4.80	4.90	5.00
D2	3.61	3.81	3.96
E	5.90	6.00	6.10
E1	5.70	5.75	5.80
E2	3.38	3.58	3.78
e	1.27 BSC		
H	0.41	0.51	0.61
K	1.10	-	-
L	0.51	0.61	0.71
L1	0.06	0.13	0.20
α	0°	-	12°



Note:

1. All Dimension Are In mm.
2. Package Body Sizes Exclude Mold Flash, Protrusion Or Gate Burrs.
Mold Flash, Protrusion Or Gate Burrs Shall Not Exceed 0.10 mm Per Side.
3. Package Body Sizes Determined At The Outermost Extremes Of The Plastic Body Exclusive Of Mold Flash, Tie Bar , Tie Bar Burrs, Gate Burrs And Interlead Flash, But Including Any Mismatch Between The Top And Bottom Of The Plastic Body.
4. The Package Top May Be Smaller Than The Package Bottom.

DFN5X6-8L(P) Package Information

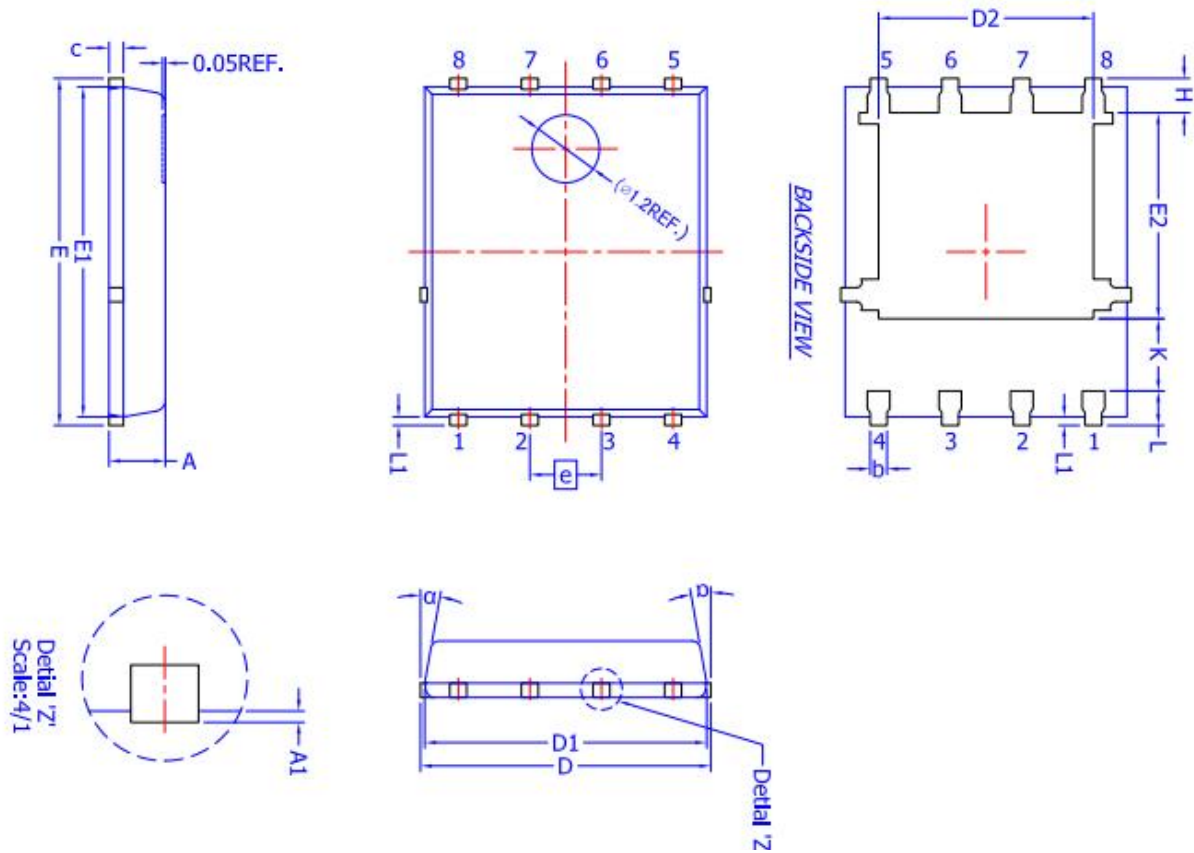

DIM.	MILLIMETERS		
	MIN.	NOM.	MAX.
A	0.90	1.00	1.10
A1	0	-	0.05
b	0.30	0.40	0.50
c	0.20	0.25	0.30
D	5.15 BSC		
D1	5.00 BSC		
D2	3.76	3.81	3.86
E	6.15 BSC		
E1	5.80	5.85	5.90
E2	3.45	3.65	3.85
e	1.27 BSC		
H	0.51	0.61	0.71
K	1.10	-	-
L	0.51	0.61	0.71
L1	0.08	0.15	0.23
α	10°	11°	12°

Note:

- All Dimension Are In mm;
- Package Body Sizes Exclude Mold Flash,Protrusion Or Gate Burrs.
Mold Flash,Protrusion Or Gate Burrs Shall Not Exceed 0.10mm Per Side.
- Package Body Sizes Determined At The Outermost Extremes Of The Plastic.
Body Exclusive Of Mold Flash,Tie Bar, Tie Bar Burrs Gate Burrs And Interlead Flash,
But Including Any Mismatch Between The Top And Bottom Of The Plastic Body.
- The Package Top May Be Smaller Than The Package Bottom.

Attention:

- Any and all NCE power products described or contained herein do not have specifications that can handle applications that require extremely high levels of reliability, such as life-support systems, aircraft's control systems, or other applications whose failure can be reasonably expected to result in serious physical and/or material damage. Consult with your NCE power representative nearest you before using any NCE power products described or contained herein in such applications.
- NCE power assumes no responsibility for equipment failures that result from using products at values that exceed, even momentarily, rated values (such as maximum ratings, operating condition ranges, or other parameters) listed in products specifications of any and all NCE power products described or contained herein.
- Specifications of any and all NCE power products described or contained herein stipulate the performance, characteristics, and functions of the described products in the independent state, and are not guarantees of the performance, characteristics, and functions of the described products as mounted in the customer's products or equipment. To verify symptoms and states that cannot be evaluated in an independent device, the customer should always evaluate and test devices mounted in the customer's products or equipment.
- NCE power Semiconductor CO.,LTD. strives to supply high-quality high-reliability products. However, any and all semiconductor products fail with some probability. It is possible that these probabilistic failures could give rise to accidents or events that could endanger human lives, that could give rise to smoke or fire, or that could cause damage to other property. When designing equipment, adopt safety measures so that these kinds of accidents or events cannot occur. Such measures include but are not limited to protective circuits and error prevention circuits for safe design, redundant design, and structural design.
- In the event that any or all NCE power products(including technical data, services) described or contained herein are controlled under any of applicable local export control laws and regulations, such products must not be exported without obtaining the export license from the authorities concerned in accordance with the above law.
- No part of this publication may be reproduced or transmitted in any form or by any means, electronic or mechanical, including photocopying and recording, or any information storage or retrieval system, or otherwise, without the prior written permission of NCE power Semiconductor CO.,LTD.
- Information (including circuit diagrams and circuit parameters) herein is for example only ; it is not guaranteed for volume production. NCE power believes information herein is accurate and reliable, but no guarantees are made or implied regarding its use or any infringements of intellectual property rights or other rights of third parties.
- Any and all information described or contained herein are subject to change without notice due to product/technology improvement, etc. When designing equipment, refer to the "Delivery Specification" for the NCE power product that you intend to use.
- This catalog provides information as of Sep.2010. Specifications and information herein are subject to change without notice.