

**Crystal Oscillator (SPXO)**

- Package size (7.0 mm × 5.0 mm × 1.3 mm)
- Fundamental mode SPXO
- Output: CMOS
- Reference weight Typ.143 mg

**[ 1 ] Product Number / Product Name / Marking**

(1-1) Product Number / Ordering Code

**X1G0053010020xx**Last 2 digits code(**xx**) defines Quantity.

The standard is "00", 1 000 pcs/Reel.

(1-2) Product Name / Model Name

**SG-9101CA 50.00000 MHz D40PGAAA****[ 2 ] Operating Range**

Parameter	Symbol	Specifications			Unit	Conditions
		Min.	Typ.	Max.		
Supply voltage	V <sub>CC</sub>	1.62	-	3.63	V	-
	GND	0	0	0	V	-
Operating temperature range	T <sub>use</sub>	-40	+25	+85	°C	-
CMOS load condition	L <sub>CMOS</sub>	-	-	15	pF	-

**[ 3 ] Frequency Characteristics**

(Unless stated otherwise [ 2 ] Operating Range)

Parameter	Symbol	Specifications			Unit	Conditions
		Min.	Typ.	Max.		
Output frequency	f <sub>o</sub>	-	50.000000	-	MHz	-
Frequency tolerance *1	f <sub>tol</sub>	-50	-	+50	×10 <sup>-6</sup>	T <sub>use</sub>

\*1 Frequency tolerance includes Initial frequency tolerance, Frequency / temperature characteristics, Frequency / voltage coefficient  
Frequency / load coefficient and frequency aging (+25 °C. First year)

**[ 4 ] Electrical Characteristics**

(Unless stated otherwise [ 2 ] Operating Range)

Parameter	Symbol	Specifications			Unit	Conditions
		Min.	Typ.	Max.		
Start-up time	t <sub>str</sub>	-	-	3	ms	t = 0 at 90 % V <sub>CC</sub>
Current consumption	I <sub>CC</sub>	-	3.9	4.6	mA	No load condition, V <sub>CC</sub> = 3.3 V
Disable current	I <sub>dis</sub>	-	3.1	3.7	mA	OE = GND, V <sub>CC</sub> = 3.3 V
Output voltage	V <sub>OH</sub>	90 % V <sub>CC</sub>	-	-	V	I <sub>OH</sub> = -5 mA @V <sub>CC</sub> = 3.3 V
	V <sub>OL</sub>	-	-	10 % V <sub>CC</sub>	V	I <sub>OL</sub> = 5 mA @V <sub>CC</sub> = 3.3 V
Rise time	t <sub>r</sub>	-	-	3	ns	20 % V <sub>CC</sub> to 80 % V <sub>CC</sub> Level, L <sub>CMOS</sub> = 15 pF, V <sub>CC</sub> = 3.3 V
Fall time	t <sub>f</sub>	-	-	3	ns	80 % V <sub>CC</sub> to 20 % V <sub>CC</sub> Level, L <sub>CMOS</sub> = 15 pF, V <sub>CC</sub> = 3.3 V
Symmetry	SYM	45	-	55	%	50 % V <sub>CC</sub> Level, L <sub>CMOS</sub> ≤ 15 pF
Input voltage	V <sub>IH</sub>	70 % V <sub>CC</sub>	-	-	V	OE terminal
	V <sub>IL</sub>	-	-	30 % V <sub>CC</sub>	V	OE terminal
Output disable time (OE)	t <sub>stp_oe</sub>	-	-	1	μs	OE terminal HIGH → LOW
Output enable time (OE)	t <sub>sta_oe</sub>	-	-	1	μs	OE terminal LOW → HIGH
Cycle to Cycle jitter	t <sub>c-c</sub>	-	-	44.6	ps	Clock cycle > 50 000, V <sub>CC</sub> = 3.3 V

**[ 5 ] Spread Spectrum Configuration**

Parameter	Setting	Unit	Conditions
Spread type	Down spread	-	-
Spread width	0 to -4.0	%	-
Modulation frequency	25,4	kHz	-
Spread profile	Hershey-kiss	-	-

**[ For other general specifications, please refer to the attached Full Data Sheet below ]**

**Programmable Spread Spectrum Crystal Oscillator:****SG-9101CG/SG-9101CE/SG-9101CB/SG-9101CA****Features**

- Spread Spectrum Crystal oscillator (Programmable)
- Output frequency: 0.67 MHz to 170 MHz ( $1 \times 10^{-6}$  Step)
- Output: CMOS
- Supply voltage: 1.62 V to 3.63 V
- Configurable spread spectrum settings:
  - 2 kinds of spread type, 6 kinds of spread width
  - 4 kinds of modulation frequency, 3 kinds of spread profile

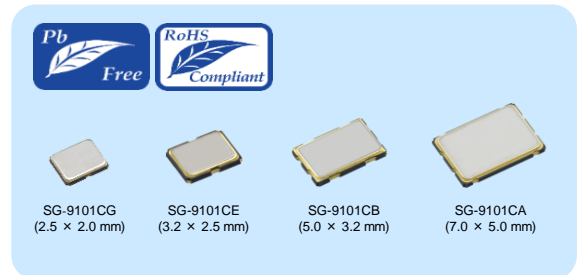
**Description**

Epson's SG-9101 series are Programmable Crystal Oscillator series with CMOS output.

While this series offer the same easy programmability of frequencies and other parameters as comparable earlier Epson products, they also have a wider operating temperature range, with a top-end limit of 105 °C. In addition to a 2.5 × 2.0 mm package that will enable electronics manufacturers to save board space, the oscillators will also be available in the following popular package sizes: 3.2 × 2.5 mm, 5.0 × 3.2 mm and 7.0 × 5.0 mm.

Users will be able to program the products to the required output frequency, as well as to the required spread spectrum settings, with an Epson SG-Writer II (sold separately).

This will also significantly contribute to performance, lower power requirements, fast development cycles, and low-volume production.

**Outline Drawing and Terminal Assignment**

SG-9101CG

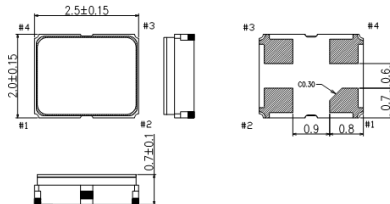

SG-9101CE

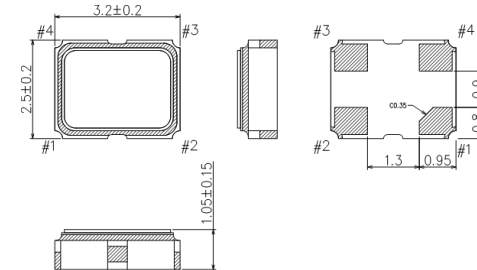

SG-9101CB

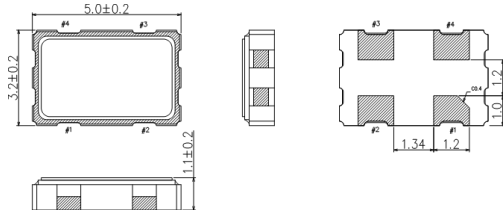

SG-9101CA

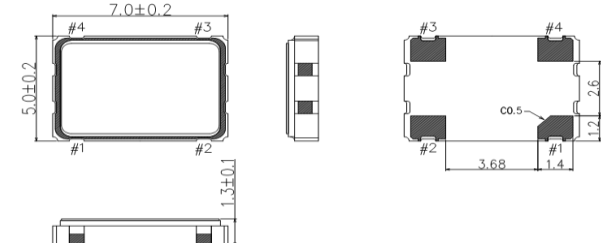
**Terminal Assignment**

Pin #	Connection	Function		
#1	OE *	OE terminal		
		OE function	Osc. Circuit	Output
		"H"	Oscillation	Specified frequency: Enable
	"L"	Oscillation	Low (weak pull down): Disable	
	$\overline{\text{ST}}$ *	$\overline{\text{ST}}$ terminal		
		$\overline{\text{ST}}$ function	Osc. Circuit	Output
"H"		Oscillation	Specified frequency: Enable	
"L"		Oscillation stop	Low (weak pull down): Disable	
#2	GND	GND terminal		
#3	OUT	Output terminal		
#4	V <sub>CC</sub>	V <sub>CC</sub> terminal		

\* Please do not use the OE/ $\overline{\text{ST}}$  terminal in the open state.

## [ 1 ] Product Name / Product Number

## (1-1) Product Name (Standard Form)

SG-9101CG: X1G005291xxxx00

SG-9101CE: X1G005321xxxx00

SG-9101CB: X1G005311xxxx00

SG-9101CA: X1G005301xxxx00

(Please contact Epson for details)

## (1-2) Product Number / Ordering Code

SG-9101CA 25.00000MHz C 20 P H A A A

① ② ③ ④ ⑤ ⑥ ⑦ ⑧ ⑨ ⑩

① Model ② Size ③ Frequency ④ Spread type ⑤ Spread width ⑥ Function

⑦ Operating temperature ⑧ Modulation frequency ⑨ Spread profile ⑩ Rise time/Fall time

② Size	
CG	2.5 mm × 2.0 mm
CE	3.2 mm × 2.5 mm
CB	5.0 mm × 3.2 mm
CA	7.0 mm × 5.0 mm

④ Spread type	
C	Center spread
D	Down spread

⑤ Spread width		
	Center spread	Down spread
02	±0.25 %	
05	±0.5 %	-0.5 %
07	±0.75 %	
10	±1.0 %	-1.0 %
15	±1.5 %	-1.5 %
20	±2.0 %	-2.0 %
30		-3.0 %
40		-4.0 %

⑥ Function	
P	Output enable (#1pin = OE)
S	Standby (#1pin = ST)

⑦ Operating temperature	
G	-40 °C to +85 °C
H	-40 °C to +105 °C

⑧ Modulation frequency	
A	25.4 kHz (default)
B	12.7 kHz
C	8.5 kHz
D	6.3 kHz

⑨ Spread profile	
A	Hershey-kiss (default)
B	Sine-wave
C	Triangle

⑩ Rise time/Fall time	
A	Default
B	Fast
C*	Slow

\* Available only when  $f_o \leq 20$  MHz

## [ 2 ] Absolute Maximum Ratings

Parameter	Symbol	Specification			Unit	Conditions
		Min.	Typ.	Max.		
Maximum supply voltage	$V_{CC}$	-0.3	-	4	V	
Input voltage	$V_{IN}$	-0.3	-	$V_{CC} + 0.3$	V	OE/ST terminal
Storage temperature range	$T_{stg}$	-40	-	+125	°C	

## [ 3 ] Operating Range

Parameter	Symbol	Specification			Unit	Conditions
		Min.	Typ.	Max.		
Supply voltage	$V_{CC}$	1.62	-	3.63	V	
Supply voltage	GND	0.0	0.0	0.0	V	
Input voltage	$V_{IN}$	GND	-	$V_{CC}$	V	OE/ST terminal
Operating temperature range	$T_{use}$	-40	+25	+85	°C	
		-40	+25	+105	°C	
CMOS load condition	$L_{CMOS}$	-	-	15	pF	

\* Power supply startup time (0 %  $V_{CC}$  → 90 %  $V_{CC}$ ) should be between 5  $\mu$ s and 500 ms\* A 0.1  $\mu$ F or over bypass capacitor should be connected between  $V_{CC}$  and GND pins located close to the device

## [ 4 ] Frequency Characteristics

(Unless stated otherwise [ 3 ] Operating Range)

Parameter	Symbol	Specification			Unit	Conditions
		Min.	Typ.	Max.		
Output frequency	$f_o$	0.67		170	MHz	
Frequency tolerance *1 *2	$f_{tol}$	-50	-	+50	$\times 10^{-6}$	$T_{use} = -40$ °C to +85 °C, $T_{use} = -40$ °C to +105 °C
Frequency aging	$f_{age}$	Included in frequency tolerance			$\times 10^{-6}$	+25 °C, First year

\*1 Frequency tolerance includes initial frequency tolerance, frequency / temperature characteristics, frequency / voltage coefficient, frequency / load coefficient and frequency aging (+25 °C, first year)

\*2 Average frequency with 1 s gate time.

## [ 5 ] Electrical Characteristics

(Unless stated otherwise [ 3 ] Operating Range)

Parameter	Symbol	Specification			Unit	Conditions																														
		Min.	Typ.	Max.																																
Start-up time	t_str	-	-	3.0	ms	t = 0 at V <sub>CC</sub> > 1.62 V																														
Current consumption (No load) V <sub>CC</sub> = 1.62 V to 1.98 V	I <sub>CC</sub>	-	2.9	3.4	mA	0.67 MHz ≤ fo ≤ 20 MHz																														
		-	3.3	3.9		20 MHz < fo ≤ 50 MHz																														
		-	3.7	4.2		50 MHz < fo ≤ 75 MHz																														
		-	4.0	4.6		75 MHz < fo ≤ 100 MHz																														
		-	4.3	5.0		100 MHz < fo ≤ 125 MHz																														
		-	4.9	5.7		125 MHz < fo ≤ 170 MHz																														
Current consumption (No load) V <sub>CC</sub> = 1.98 V to 2.20 V	I <sub>CC</sub>	-	2.9	3.5	mA	0.67 MHz ≤ fo ≤ 20 MHz																														
		-	3.3	4.0		20 MHz < fo ≤ 50 MHz																														
		-	3.7	4.4		50 MHz < fo ≤ 75 MHz																														
		-	4.0	4.8		75 MHz < fo ≤ 100 MHz																														
		-	4.3	5.2		100 MHz < fo ≤ 125 MHz																														
		-	4.9	6.0		125 MHz < fo ≤ 170 MHz																														
Current consumption (No load) V <sub>CC</sub> = 2.20 V to 2.80 V	I <sub>CC</sub>	-	3.0	3.6	mA	0.67 MHz ≤ fo ≤ 20 MHz																														
		-	3.6	4.2		20 MHz < fo ≤ 50 MHz																														
		-	4.1	4.8		50 MHz < fo ≤ 75 MHz																														
		-	4.6	5.3		75 MHz < fo ≤ 100 MHz																														
		-	5.0	5.9		100 MHz < fo ≤ 125 MHz																														
		-	5.9	6.9		125 MHz < fo ≤ 170 MHz																														
Current consumption (No load) V <sub>CC</sub> = 2.70 V to 3.63 V	I <sub>CC</sub>	-	3.2	3.7	mA	0.67 MHz ≤ fo ≤ 20 MHz																														
		-	3.9	4.6		20 MHz < fo ≤ 50 MHz																														
		-	4.6	5.4		50 MHz < fo ≤ 75 MHz																														
		-	5.2	6.1		75 MHz < fo ≤ 100 MHz																														
		-	5.9	6.9		100 MHz < fo ≤ 125 MHz																														
		-	7.0	8.3		125 MHz < fo ≤ 170 MHz																														
Disable current	I <sub>dis</sub>	-	2.8	3.4	mA	V <sub>CC</sub> = 1.62 V to 1.98 V																														
		-	2.8	3.4		V <sub>CC</sub> = 1.98 V to 2.20 V																														
		-	3.0	3.5		V <sub>CC</sub> = 2.20 V to 2.80 V																														
		-	3.1	3.7		V <sub>CC</sub> = 2.70 V to 3.63 V																														
Stand-by current	I <sub>std</sub>	-	0.3	0.9	μA	V <sub>CC</sub> = 1.62 V to 1.98 V																														
		-	0.4	1.0		V <sub>CC</sub> = 1.98 V to 2.20 V																														
		-	0.5	1.5		V <sub>CC</sub> = 2.20 V to 2.80 V																														
		-	1.1	2.5		V <sub>CC</sub> = 2.70 V to 3.63 V																														
Output voltage (DC characteristics)	V <sub>OH</sub>	90 % V <sub>CC</sub>	-	-	V	<table border="1"> <thead> <tr> <th colspan="2">I<sub>OH</sub> Condition</th> <th colspan="4">V<sub>CC</sub> [V]</th> </tr> <tr> <th colspan="2">tr/tf</th> <th>1.62 to 1.98</th> <th>1.98 to 2.20</th> <th>2.20 to 2.80</th> <th>2.70 to 3.63</th> </tr> </thead> <tbody> <tr> <td>A (fo &gt; 40 MHz), B</td> <td>-2.5 mA</td> <td>-3.5 mA</td> <td>-4.0 mA</td> <td>-5.0 mA</td> <td></td> </tr> <tr> <td>A (fo ≤ 40 MHz)</td> <td>-1.5 mA</td> <td>-2.0 mA</td> <td>-2.5 mA</td> <td>-3.0 mA</td> <td></td> </tr> <tr> <td>C</td> <td>-1.0 mA</td> <td>-1.5 mA</td> <td>-2.0 mA</td> <td>-2.5 mA</td> <td></td> </tr> </tbody> </table>	I <sub>OH</sub> Condition		V <sub>CC</sub> [V]				tr/tf		1.62 to 1.98	1.98 to 2.20	2.20 to 2.80	2.70 to 3.63	A (fo > 40 MHz), B	-2.5 mA	-3.5 mA	-4.0 mA	-5.0 mA		A (fo ≤ 40 MHz)	-1.5 mA	-2.0 mA	-2.5 mA	-3.0 mA		C	-1.0 mA	-1.5 mA	-2.0 mA	-2.5 mA	
	I <sub>OH</sub> Condition		V <sub>CC</sub> [V]																																	
tr/tf		1.62 to 1.98	1.98 to 2.20	2.20 to 2.80	2.70 to 3.63																															
A (fo > 40 MHz), B	-2.5 mA	-3.5 mA	-4.0 mA	-5.0 mA																																
A (fo ≤ 40 MHz)	-1.5 mA	-2.0 mA	-2.5 mA	-3.0 mA																																
C	-1.0 mA	-1.5 mA	-2.0 mA	-2.5 mA																																
V <sub>OL</sub>	-	-	10 % V <sub>CC</sub>	V	<table border="1"> <thead> <tr> <th colspan="2">I<sub>OL</sub> Condition</th> <th colspan="4">V<sub>CC</sub> [V]</th> </tr> <tr> <th colspan="2">tr/tf</th> <th>1.62 to 1.98</th> <th>1.98 to 2.20</th> <th>2.20 to 2.80</th> <th>2.70 to 3.63</th> </tr> </thead> <tbody> <tr> <td>A (fo &gt; 40 MHz), B</td> <td>2.5 mA</td> <td>3.5 mA</td> <td>4.0 mA</td> <td>5.0 mA</td> <td></td> </tr> <tr> <td>A (fo ≤ 40 MHz)</td> <td>1.5 mA</td> <td>2.0 mA</td> <td>2.5 mA</td> <td>3.0 mA</td> <td></td> </tr> <tr> <td>C</td> <td>1.0 mA</td> <td>1.5 mA</td> <td>2.0 mA</td> <td>2.5 mA</td> <td></td> </tr> </tbody> </table>	I <sub>OL</sub> Condition		V <sub>CC</sub> [V]				tr/tf		1.62 to 1.98	1.98 to 2.20	2.20 to 2.80	2.70 to 3.63	A (fo > 40 MHz), B	2.5 mA	3.5 mA	4.0 mA	5.0 mA		A (fo ≤ 40 MHz)	1.5 mA	2.0 mA	2.5 mA	3.0 mA		C	1.0 mA	1.5 mA	2.0 mA	2.5 mA		
I <sub>OL</sub> Condition		V <sub>CC</sub> [V]																																		
tr/tf		1.62 to 1.98	1.98 to 2.20	2.20 to 2.80	2.70 to 3.63																															
A (fo > 40 MHz), B	2.5 mA	3.5 mA	4.0 mA	5.0 mA																																
A (fo ≤ 40 MHz)	1.5 mA	2.0 mA	2.5 mA	3.0 mA																																
C	1.0 mA	1.5 mA	2.0 mA	2.5 mA																																
Symmetry	SYM	45	50	55	%	50 % V <sub>CC</sub> level, L <sub>CMOS</sub> ≤ 15 pF																														
Rise time/Fall time	tr/tf	-	-	3	ns	20 % - 80 % V <sub>CC</sub> level, L <sub>CMOS</sub> = 15 pF																														
		-	-	6			A (fo > 40 MHz)																													
		-	-	3			B																													
		-	-	10			C (fo ≤ 20 MHz)																													
Input voltage	V <sub>IH</sub>	70 % V <sub>CC</sub>	-	-	V	OE/ $\overline{\text{ST}}$ terminal																														
	V <sub>IL</sub>	-	-	30 % V <sub>CC</sub>	V																															
Input capacitance	C <sub>IN</sub>	-	2.5	5	pF	OE/ $\overline{\text{ST}}$ terminal																														
Input pull up resistance	R <sub>UP1</sub>	20	-	150	kΩ	OE/ $\overline{\text{ST}}$ = 70 % V <sub>CC</sub>																														
	R <sub>UP2</sub>	5	-	60	MΩ	OE/ $\overline{\text{ST}}$ = 30 % V <sub>CC</sub>																														
Output pull down resistance	R <sub>DN</sub>	0.5	-	5	MΩ	OE/ $\overline{\text{ST}}$ = GND, OUT = V <sub>CC</sub>																														
Output disable time (OE)	tstp_oe	-	-	1	μs	OE terminal HIGH → LOW																														
Output disable time (ST)	tstp_st	-	-	1	μs	$\overline{\text{ST}}$ terminal HIGH → LOW																														
Output enable time (OE)	tsta_oe	-	-	1	μs	OE terminal LOW → HIGH																														
Output enable time (ST)	tsta_st	-	-	3	ms	$\overline{\text{ST}}$ terminal LOW → HIGH																														

(Unless stated otherwise [ 3 ] Operating Range)

Parameter	Symbol	Specification			Unit	Conditions
		Min.	Typ.	Max.		
Cycle to Cycle jitter (Clock cycle > 50 000) $V_{CC} = 1.62 \text{ V to } 1.98 \text{ V}$	$t_{c-c}$	-	-	312.1	ps	10 MHz $\leq$ fo $\leq$ 20 MHz
		-	-	225.3		20 MHz < fo $\leq$ 40 MHz
		-	-	91.7		40 MHz < fo $\leq$ 85 MHz
		-	-	70.4		85 MHz < fo $\leq$ 125 MHz
		-	-	65.6		125 MHz < fo $\leq$ 170 MHz
Cycle to Cycle jitter (Clock cycle > 50 000) $V_{CC} = 2.25 \text{ V to } 2.75 \text{ V}$		-	-	292.9	ps	10 MHz $\leq$ fo $\leq$ 20 MHz
		-	-	136.6		20 MHz < fo $\leq$ 40 MHz
		-	-	48.7		40 MHz < fo $\leq$ 85 MHz
		-	-	37.6		85 MHz < fo $\leq$ 125 MHz
		-	-	35.4		125 MHz < fo $\leq$ 170 MHz
Cycle to Cycle jitter (Clock cycle > 50 000) $V_{CC} = 2.97 \text{ V to } 3.63 \text{ V}$		-	-	290.1	ps	10 MHz $\leq$ fo $\leq$ 20 MHz
		-	-	128.8		20 MHz < fo $\leq$ 40 MHz
		-	-	44.6		40 MHz < fo $\leq$ 85 MHz
		-	-	29.3		85 MHz < fo $\leq$ 125 MHz
		-	-	26.2		125 MHz < fo $\leq$ 170 MHz
Modulation frequency	$f_{mod}$	25.0	25.4	25.5	kHz	Modulation frequency code: A
		12.4	12.7	12.8		Modulation frequency code: B
		8.2	8.5	8.6		Modulation frequency code: C
		6.1	6.3	6.5		Modulation frequency code: D

## [ 6 ] Thermal resistance (For reference only)

Parameter	Symbol	Specification			Unit	Conditions
		Min.	Typ.	Max.		
Junction temperature	$T_j$	-	-	+125	$^{\circ}\text{C}$	
Junction to case	$\theta_{jc}$	-	15.2	-	$^{\circ}\text{C/W}$	SG-9101CG
		-	23.1	-		SG-9101CE
		-	16.1	-		SG-9101CB
		-	28.0	-		SG-9101CA
Junction to ambient	$\theta_{ja}$	-	91.9	-	$^{\circ}\text{C/W}$	SG-9101CG
		-	103.8	-		SG-9101CE
		-	82.5	-		SG-9101CB
		-	78.8	-		SG-9101CA

[ 7 ] Typical Performance Characteristics (For reference only)  
 The following data shows typical performance characteristics  
 (7-1) Frequency / Temperature Characteristics

$\pm 50 \times 10^{-6}$  / -40 °C to +85 °C n = 16 pcs

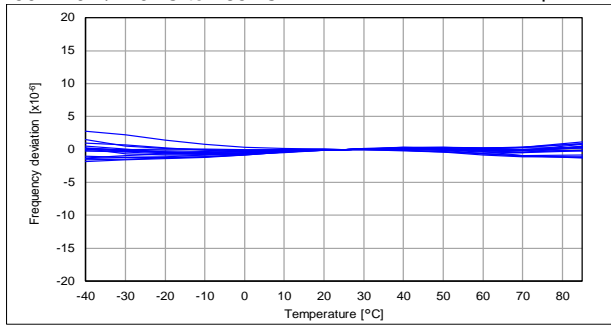

$\pm 50 \times 10^{-6}$  / -40 °C to +105 °C n = 16 pcs

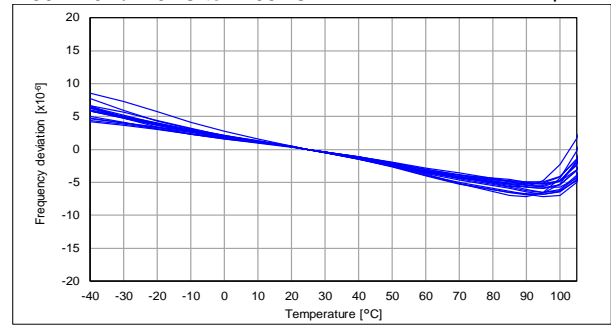

(7-2) Current Consumption

No load,  $T_{use} = +25$  °C, Freq. Dependency

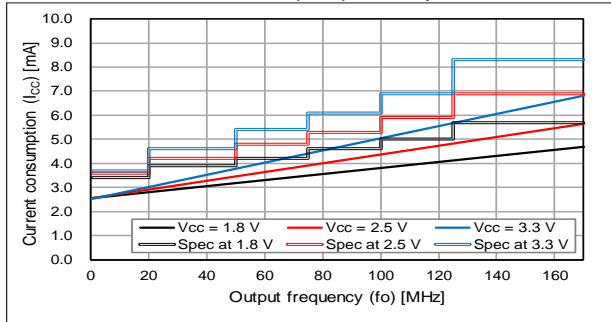

$L_{CMOS} = 15$  pF,  $T_{use} = +25$  °C, Freq. Dependency

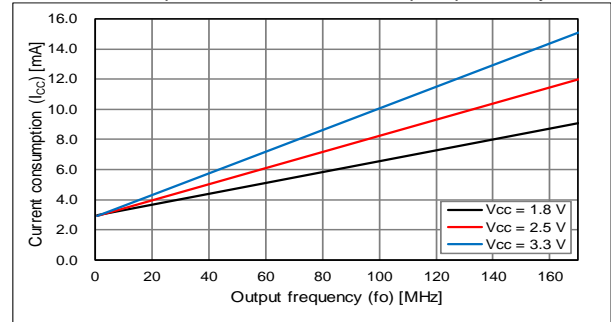

$f_o = 19.2$  MHz

$L_{CMOS} = 5$  pF, Temperature Characteristic

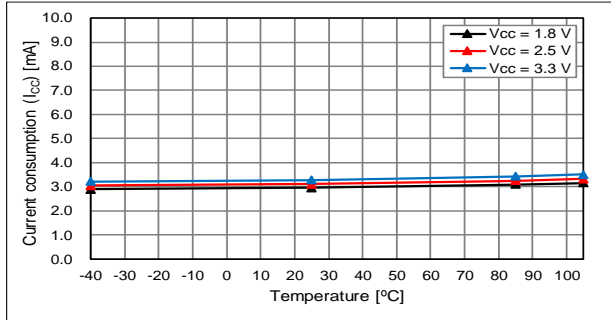

$T_{use} = +25$  °C, Output load ( $L_{CMOS}$ ) Characteristics

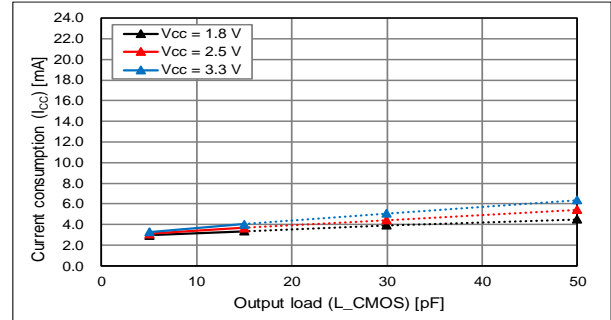

\* Output load condition under  $L_{CMOS} > 15$  pF (dotted line area) is not guaranteed, and the data is for reference.

$f_o = 40$  MHz

$L_{CMOS} = 5$  pF, Temperature Characteristic

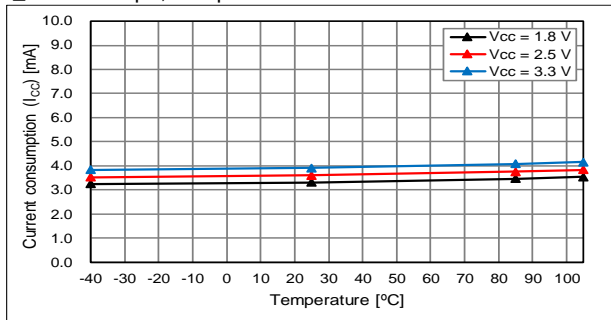

$T_{use} = +25$  °C, Output load ( $L_{CMOS}$ ) Characteristics

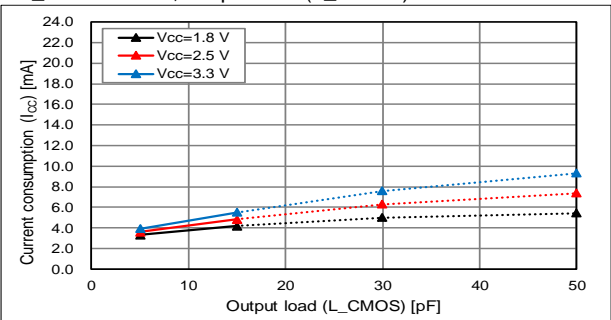

\* Output load condition under  $L_{CMOS} > 15$  pF (dotted line area) is not guaranteed, and the data is for reference.

(7-2) Current Consumption [cont'd]

fo = 60 MHz

L\_CMOS = 5 pF, Temperature Characteristic

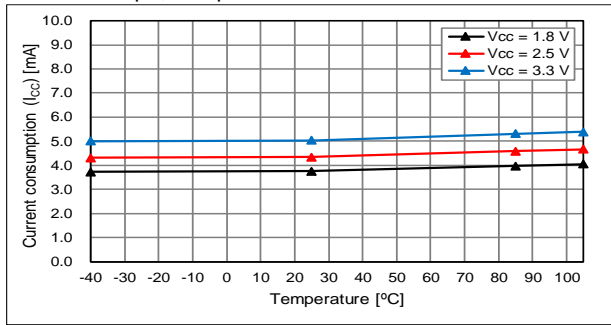

T\_use = +25 °C, Output load (L\_CMOS) Characteristics

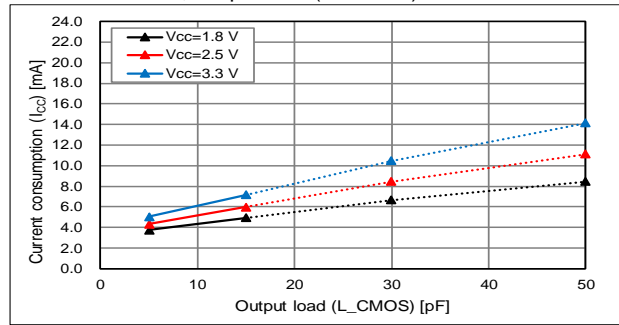

\* Output load condition under L\_CMOS > 15 pF (dotted line area) is not guaranteed, and the data is for reference.

fo = 80 MHz

L\_CMOS = 5 pF, Temperature Characteristic

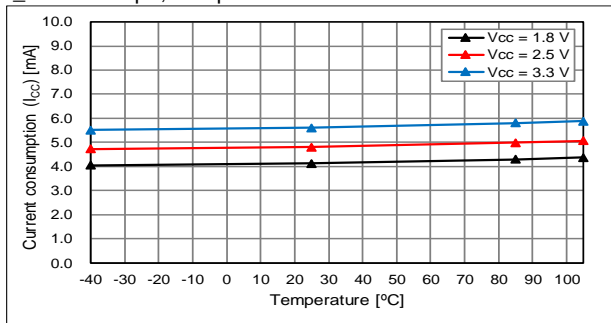

T\_use = +25 °C, Output load (L\_CMOS) Characteristics

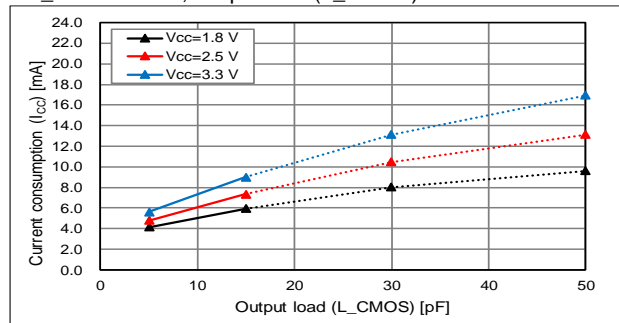

\* Output load condition under L\_CMOS > 15 pF (dotted line area) is not guaranteed, and the data is for reference.

fo = 122.88 MHz

L\_CMOS = 5 pF, Temperature Characteristic

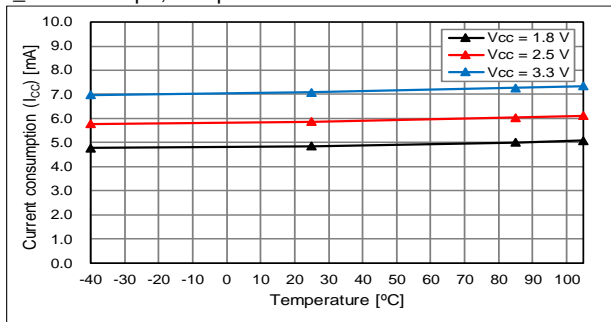

T\_use = +25 °C, Output load (L\_CMOS) Characteristics

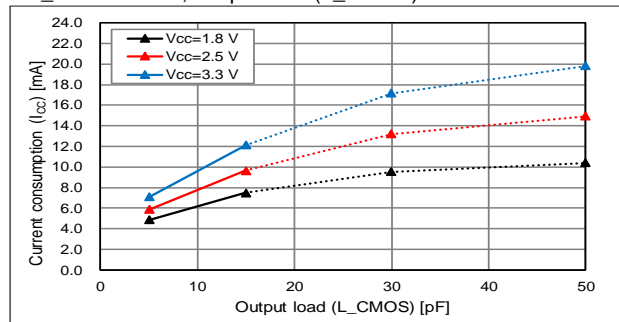

\* Output load condition under L\_CMOS > 15 pF (dotted line area) is not guaranteed, and the data is for reference.

fo = 170 MHz

L\_CMOS = 5 pF, Temperature Characteristic

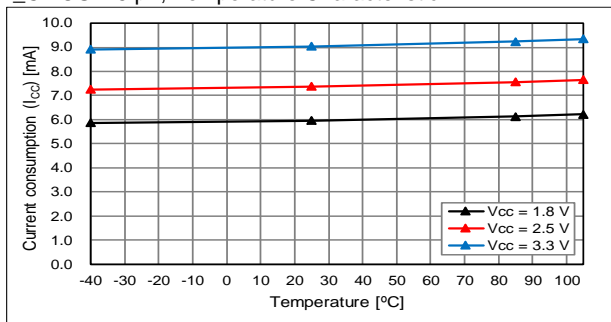

T\_use = +25 °C, Output load (L\_CMOS) Characteristics

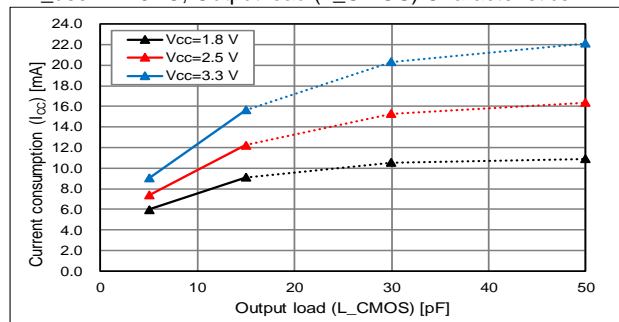

\* Output load condition under L\_CMOS > 15 pF (dotted line area) is not guaranteed, and the data is for reference.

The actual current consumption is the total of the current under the condition of no load and the current to drive the output load (fo × L\_CMOS × Vcc). To reduce the current consumption, it is effective to use lower frequency, lower supply voltage and lower output load.

(7-3) Rise Time/Fall Time

fo = 19.2 MHz, Rise time/Fall time: A (Default)

Rise Time

20% - 80% V<sub>CC</sub>, L<sub>CMOS</sub> = 15 pF, Temp. Char.

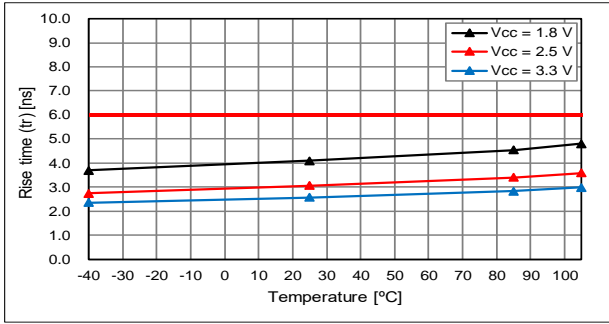

20% - 80% V<sub>CC</sub>, T<sub>use</sub> = +25 °C, Output load Char.

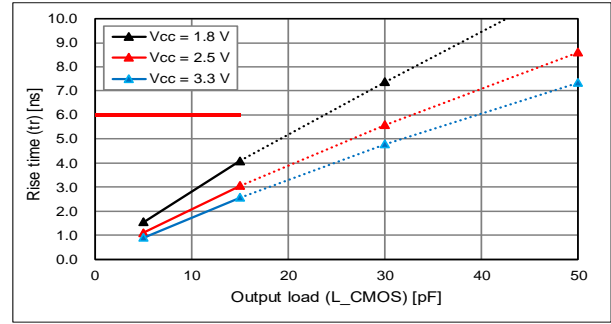

Fall Time

20% - 80% V<sub>CC</sub>, L<sub>CMOS</sub> = 15 pF, Temp. Char.

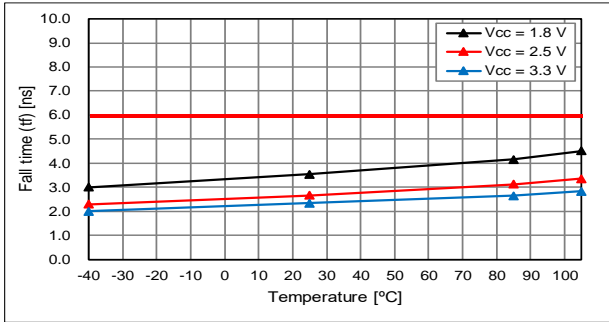

20% - 80% V<sub>CC</sub>, T<sub>use</sub> = +25 °C, Output load Char.

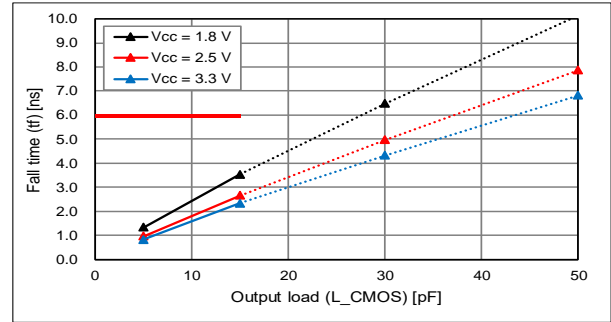

\* Output load condition under L<sub>CMOS</sub> > 15 pF (dotted line area) is not guaranteed, and the data is for reference.

fo = 19.2 MHz, Rise time/Fall time: B (Fast)

Rise Time

20% - 80% V<sub>CC</sub>, L<sub>CMOS</sub> = 15 pF, Temp. Char.

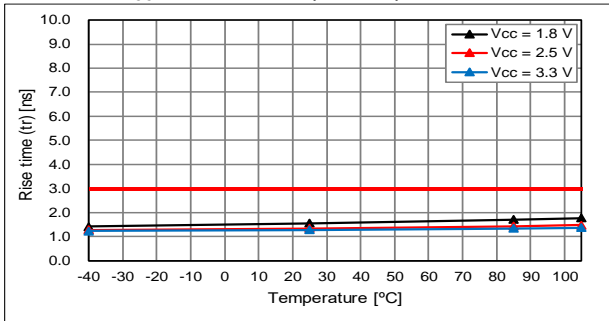

20% - 80% V<sub>CC</sub>, T<sub>use</sub> = +25 °C, Output load Char.

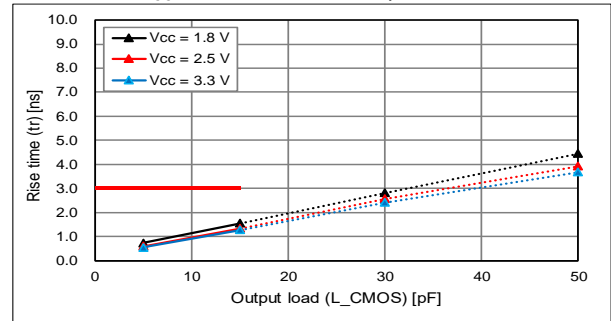

Fall Time

20% - 80% V<sub>CC</sub>, L<sub>CMOS</sub> = 15 pF, Temp. Char.

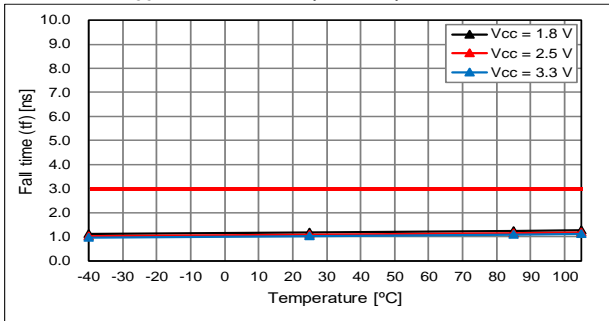

20% - 80% V<sub>CC</sub>, T<sub>use</sub> = +25 °C, Output load Char.

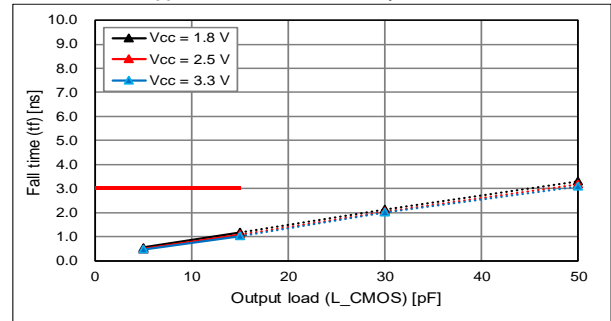

\* Output load condition under L<sub>CMOS</sub> > 15 pF (dotted line area) is not guaranteed, and the data is for reference.



(7-3) Rise Time/Fall Time [cont'd]

fo = 19.2 MHz, Rise time/Fall time: C (Slow)

Rise Time

20% - 80% V<sub>CC</sub>, L<sub>CMOS</sub> = 15 pF, Temp. Char.

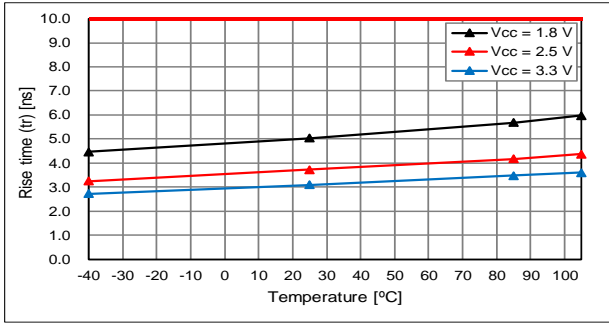

20% - 80% V<sub>CC</sub>, T<sub>use</sub> = +25 °C, Output load Char.

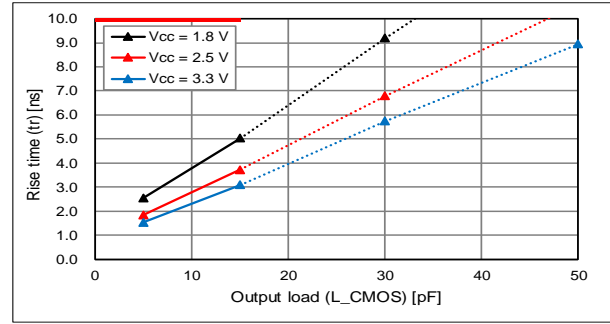

Fall Time

20% - 80% V<sub>CC</sub>, L<sub>CMOS</sub> = 15 pF, Temp. Char.

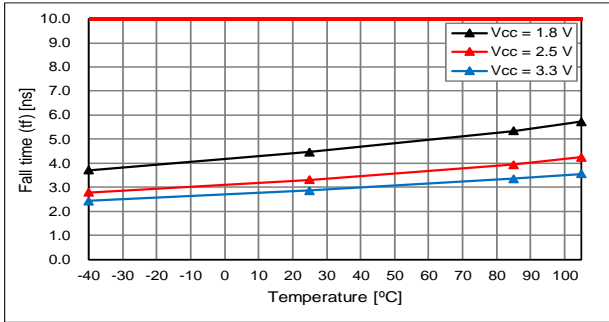

20% - 80% V<sub>CC</sub>, T<sub>use</sub> = +25 °C, Output load Char.

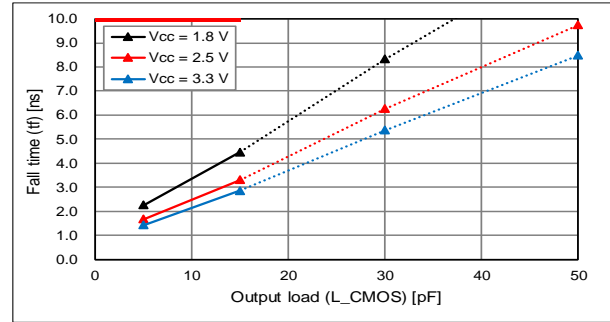

\* Output load condition under L<sub>CMOS</sub> > 15 pF (dotted line area) is not guaranteed, and the data is for reference.

(7-3) Rise Time/Fall Time [cont'd]

fo = 40 MHz, Rise time/Fall time: A (Default)

Rise Time

20% - 80% V<sub>CC</sub>, L<sub>CMOS</sub> = 15 pF, Temp. Char.

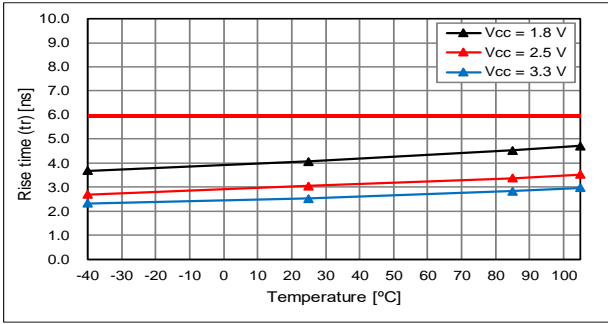

20% - 80% V<sub>CC</sub>, T<sub>use</sub> = +25 °C, Output load Char.

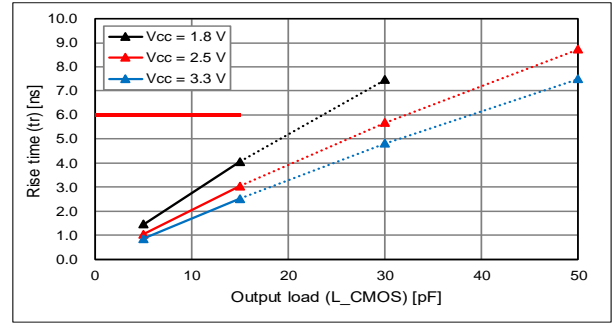

Fall Time

20% - 80% V<sub>CC</sub>, L<sub>CMOS</sub> = 15 pF, Temp. Char.

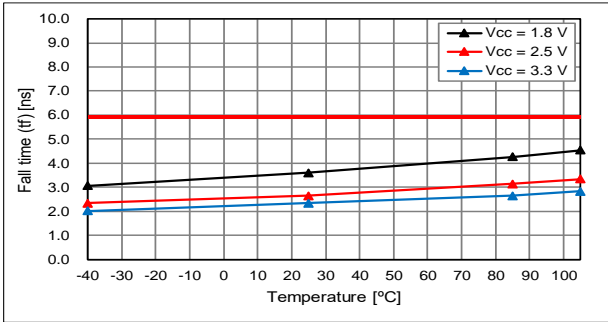

20% - 80% V<sub>CC</sub>, T<sub>use</sub> = +25 °C, Output load Char.

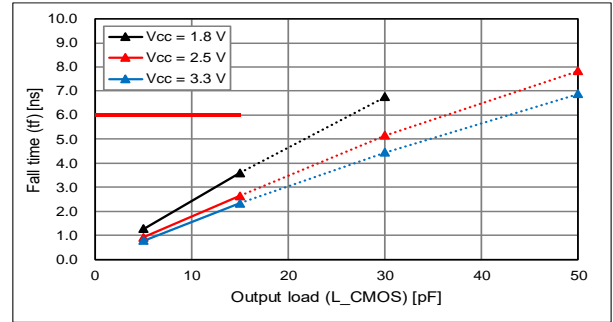

\* Output load condition under L<sub>CMOS</sub> > 15 pF (dotted line area) is not guaranteed, and the data is for reference.

fo = 40 MHz, Rise time/Fall time: B (Fast)

Rise Time

20% - 80% V<sub>CC</sub>, L<sub>CMOS</sub> = 15 pF, Temp. Char.

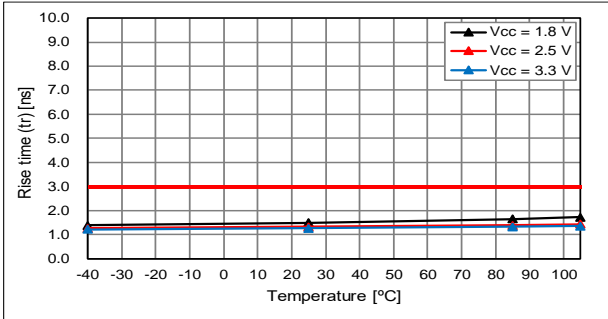

20% - 80% V<sub>CC</sub>, T<sub>use</sub> = +25 °C, Output load Char.

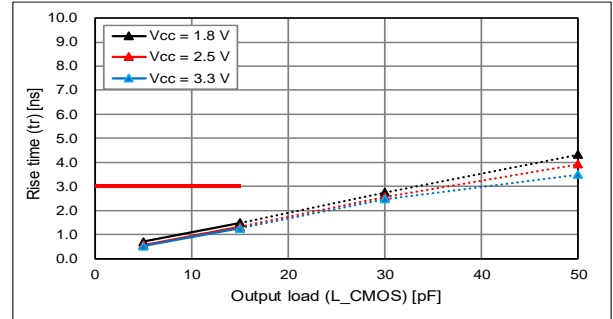

Fall Time

20% - 80% V<sub>CC</sub>, L<sub>CMOS</sub> = 15 pF, Temp. Char.

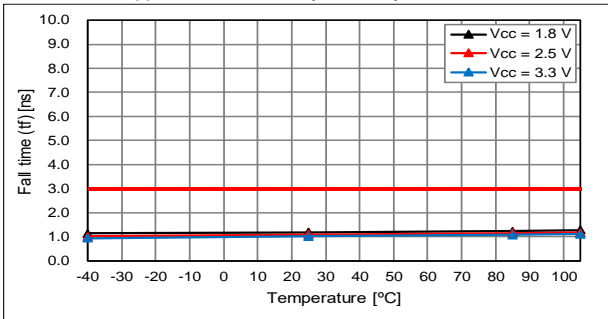

20% - 80% V<sub>CC</sub>, T<sub>use</sub> = +25 °C, Output load Char.

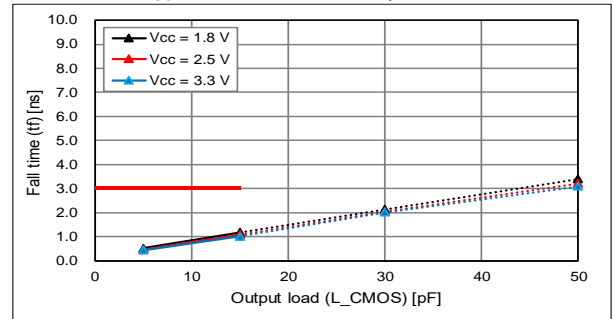

\* Output load condition under L<sub>CMOS</sub> > 15 pF (dotted line area) is not guaranteed, and the data is for reference.

(7-3) Rise Time/Fall Time [cont'd]

fo = 60 MHz, Rise time/Fall time: A (Default) & B (Fast)

Rise Time

20% - 80% V<sub>CC</sub>, L<sub>CMOS</sub> = 15 pF, Temp. Char.

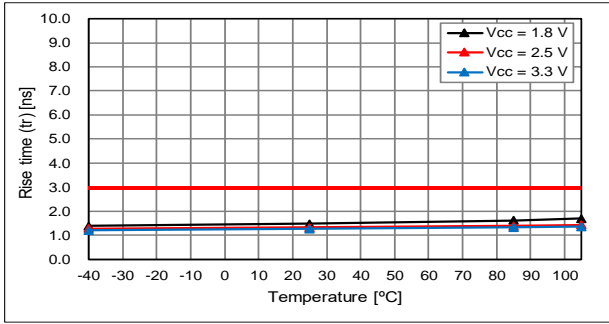

20% - 80% V<sub>CC</sub>, T<sub>use</sub> = +25 °C, Output load Char.

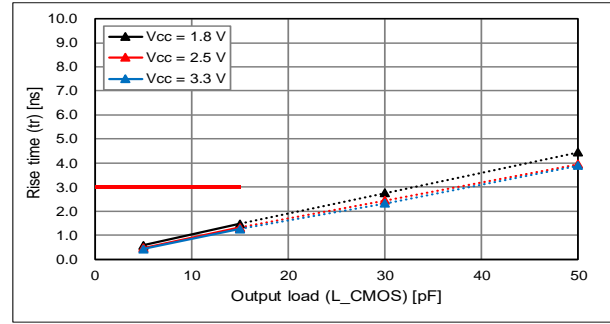

Fall Time

20% - 80% V<sub>CC</sub>, L<sub>CMOS</sub> = 15 pF, Temp. Char.

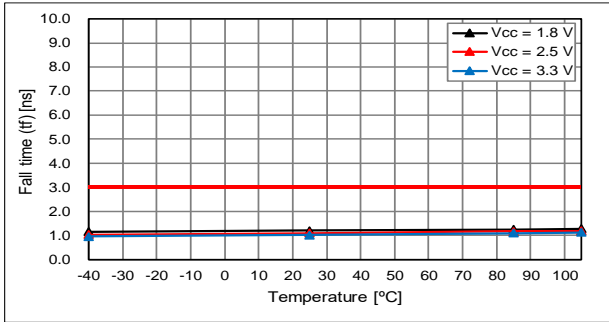

20% - 80% V<sub>CC</sub>, T<sub>use</sub> = +25 °C, Output load Char.

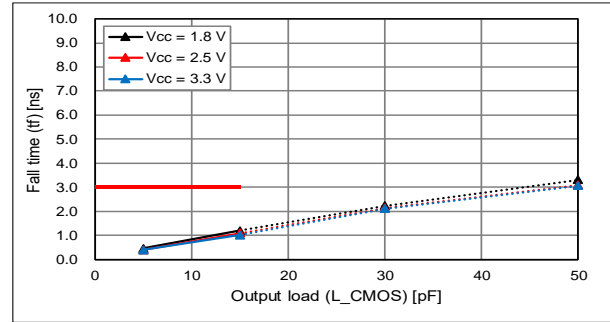

\* Output load condition under L<sub>CMOS</sub> > 15 pF (dotted line area) is not guaranteed, and the data is for reference.

fo = 80 MHz, Rise time/Fall time: A (Default) & B (Fast)

Rise Time

20% - 80% V<sub>CC</sub>, L<sub>CMOS</sub> = 15 pF, Temp. Char.

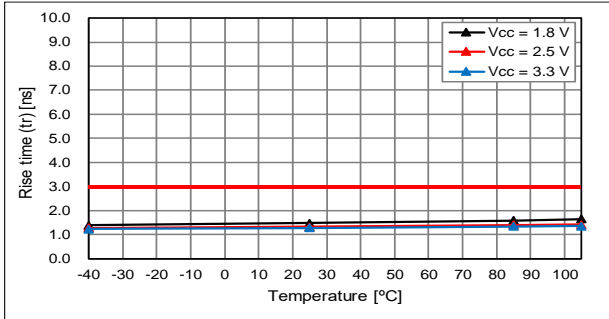

20% - 80% V<sub>CC</sub>, T<sub>use</sub> = +25 °C, Output load Char.

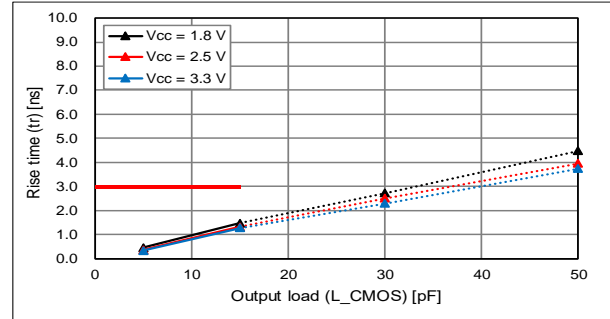

Fall Time

20% - 80% V<sub>CC</sub>, L<sub>CMOS</sub> = 15 pF, Temp. Char.

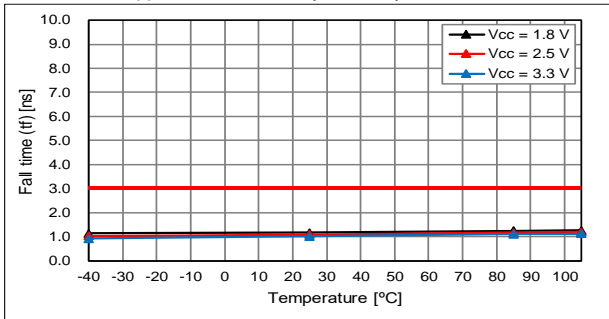

20% - 80% V<sub>CC</sub>, T<sub>use</sub> = +25 °C, Output load Char.

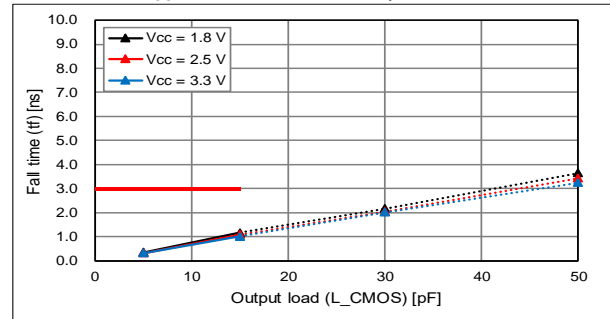

\* Output load condition under L<sub>CMOS</sub> > 15 pF (dotted line area) is not guaranteed, and the data is for reference.

(7-3) Rise Time / Fall Time [cont'd]

fo = 122.88 MHz, Rise time/Fall time: A (Default) & B (Fast)

Rise Time

20% - 80% V<sub>CC</sub>, L<sub>CMOS</sub> = 15 pF, Temp. Char.

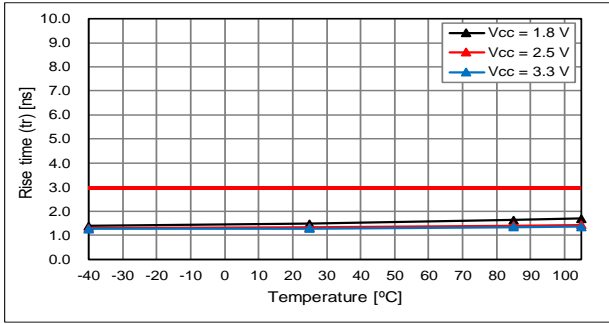

20% - 80% V<sub>CC</sub>, T<sub>use</sub> = +25 °C, Output load Char.

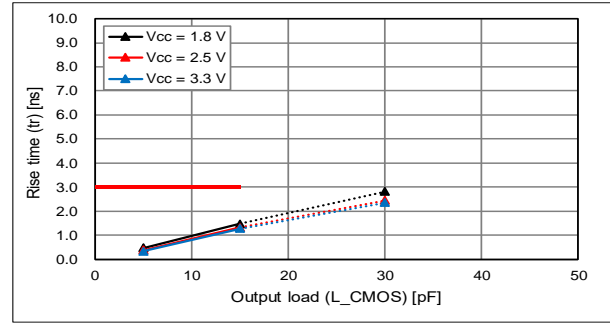

Fall Time

20% - 80% V<sub>CC</sub>, L<sub>CMOS</sub> = 15 pF, Temp. Char.

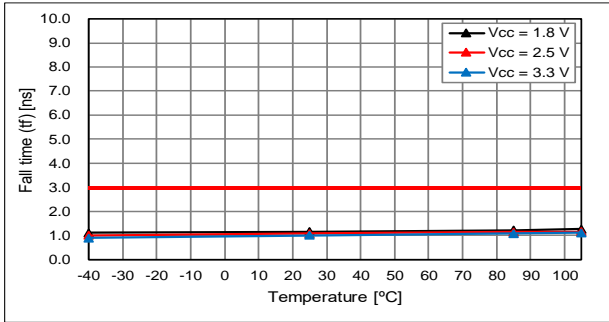

20% - 80% V<sub>CC</sub>, T<sub>use</sub> = +25 °C, Output load Char.

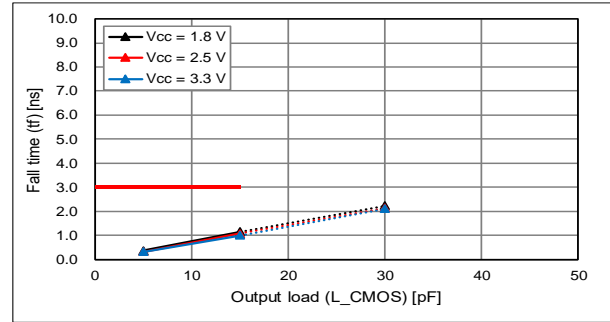

\* Output load condition under L<sub>CMOS</sub> > 15 pF (dotted line area) is not guaranteed, and the data is for reference.

fo = 170 MHz, Rise time/Fall time: A (Default) & B (Fast)

Rise Time

20% - 80% V<sub>CC</sub>, L<sub>CMOS</sub> = 15 pF, Temp. Char.

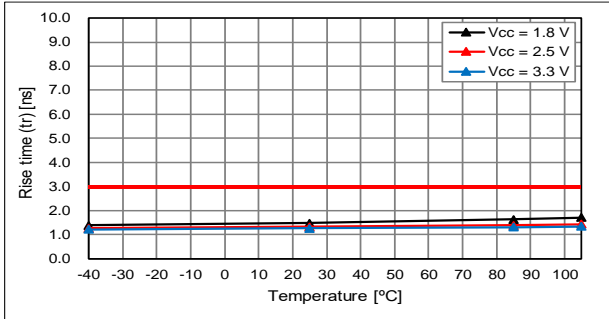

20% - 80% V<sub>CC</sub>, T<sub>use</sub> = +25 °C, Output load Char.

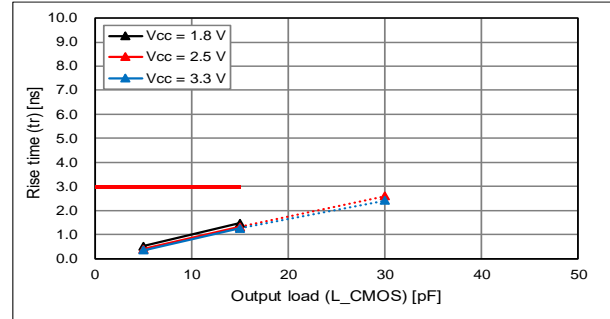

Fall Time

20% - 80% V<sub>CC</sub>, L<sub>CMOS</sub> = 15 pF, Temp. Char.

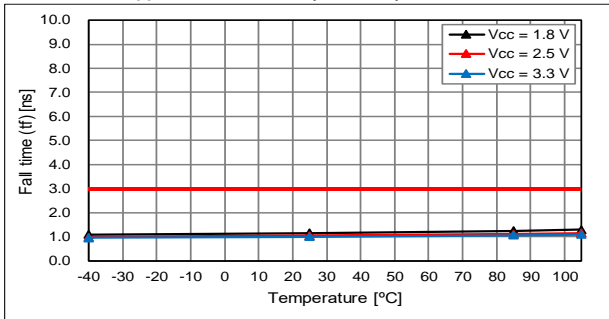

20% - 80% V<sub>CC</sub>, T<sub>use</sub> = +25 °C, Output load Char.

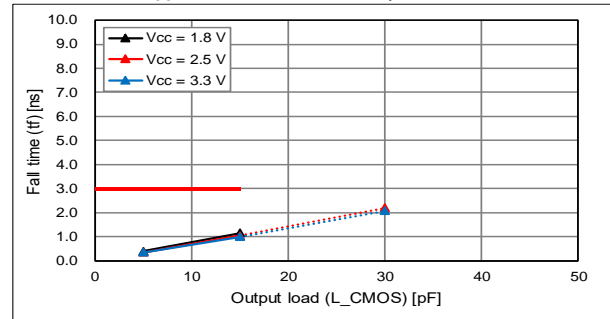

\* Output load condition under L<sub>CMOS</sub> > 15 pF (dotted line area) is not guaranteed, and the data is for reference.

(7-4) Symmetry

fo = 19.2 MHz, Rise time/Fall time: A (Default)

50 %V<sub>CC</sub>, L<sub>CMOS</sub> = 15 pF, Temp. Char.

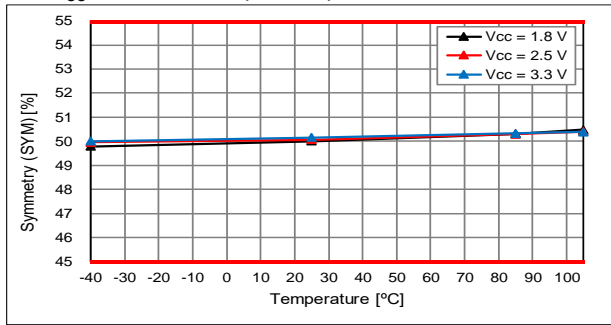

50 %V<sub>CC</sub>, T<sub>use</sub> = +25 °C, Output load Char.

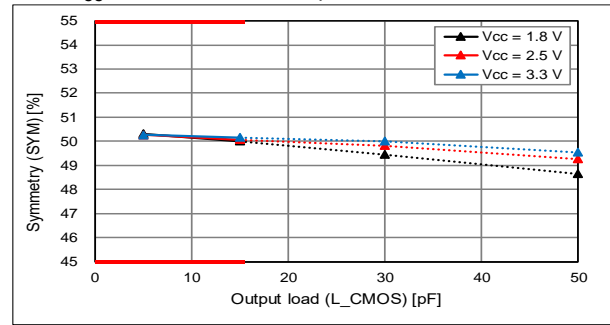

\* Output load condition under L<sub>CMOS</sub> > 15 pF (dotted line area) is not guaranteed, and the data is for reference.

fo = 19.2 MHz, Rise time/Fall time: B (Fast)

50 %V<sub>CC</sub>, L<sub>CMOS</sub> = 15 pF, Temp. Char.

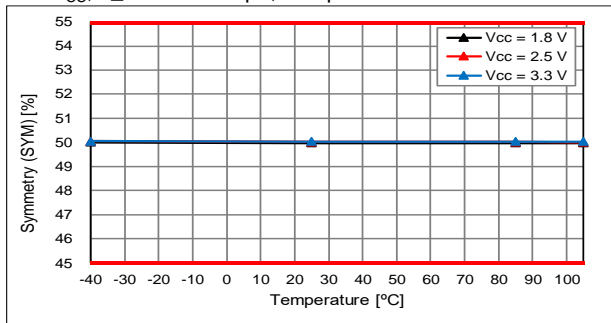

50 %V<sub>CC</sub>, T<sub>use</sub> = +25 °C, Output load Char.

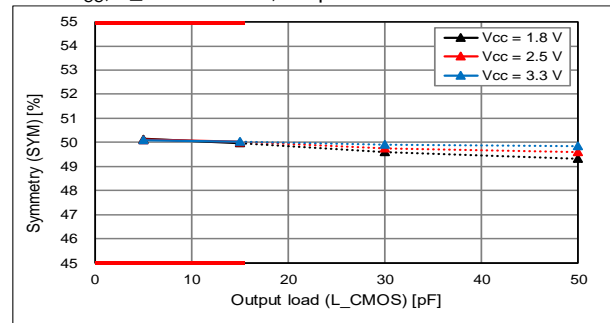

\* Output load condition under L<sub>CMOS</sub> > 15 pF (dotted line area) is not guaranteed, and the data is for reference.

fo = 19.2 MHz, Rise time/Fall time: C (Slow)

50 %V<sub>CC</sub>, L<sub>CMOS</sub> = 15 pF, Temp. Char.

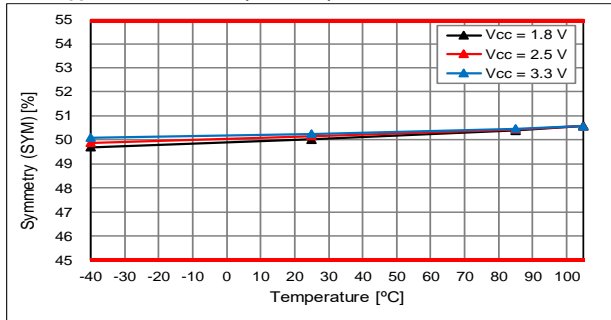

50 %V<sub>CC</sub>, T<sub>use</sub> = +25 °C, Output load Char.

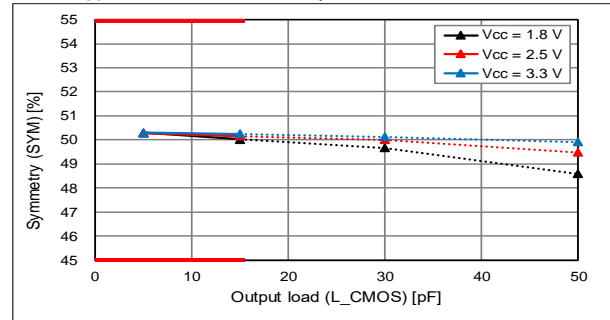

\* Output load condition under L<sub>CMOS</sub> > 15 pF (dotted line area) is not guaranteed, and the data is for reference.

(7-4) Symmetry [cont'd]

fo = 40 MHz, Rise time/Fall time: A (Default)

50 %V<sub>CC</sub>, L<sub>CMOS</sub> = 15 pF, Temp. Char.

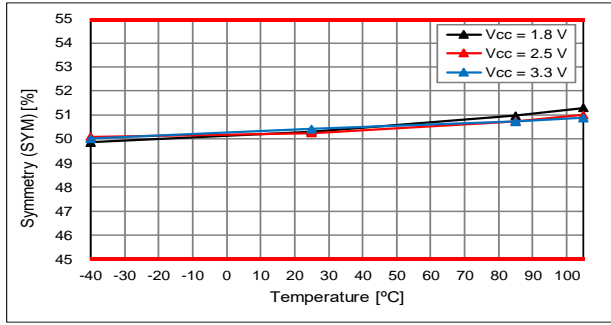

50 %V<sub>CC</sub>, T<sub>use</sub> = +25 °C, Output load Char.

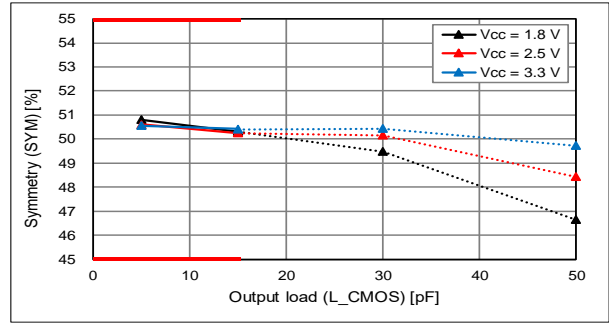

\* Output load condition under L<sub>CMOS</sub> > 15 pF (dotted line area) is not guaranteed, and the data is for reference.

fo = 40 MHz, Rise time/Fall time: B (Fast)

50 %V<sub>CC</sub>, L<sub>CMOS</sub> = 15 pF, Temp. Char.

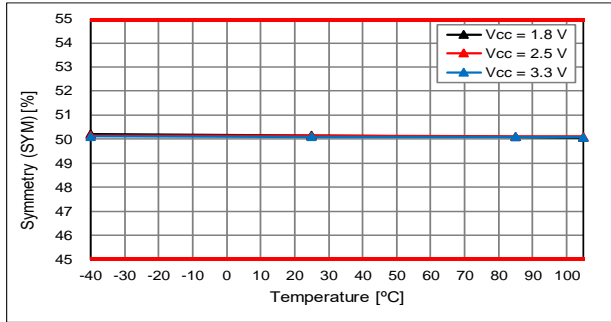

50 %V<sub>CC</sub>, T<sub>use</sub> = +25 °C, Output load Char.

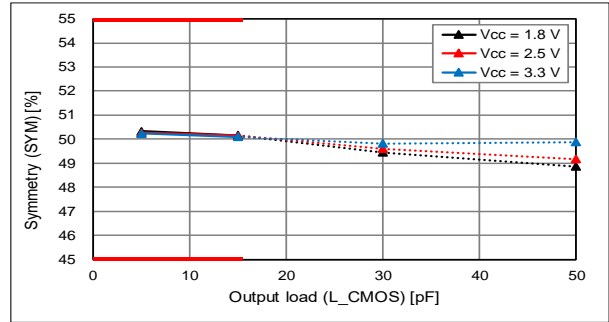

\* Output load condition under L<sub>CMOS</sub> > 15 pF (dotted line area) is not guaranteed, and the data is for reference.

fo = 60 MHz, Rise time/Fall time: A (Default) & B (Fast)

50 %V<sub>CC</sub>, L<sub>CMOS</sub> = 15 pF, Temp. Char.

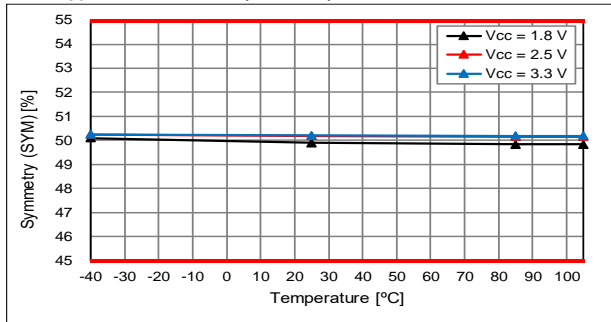

50 %V<sub>CC</sub>, T<sub>use</sub> = +25 °C, Output load Char.

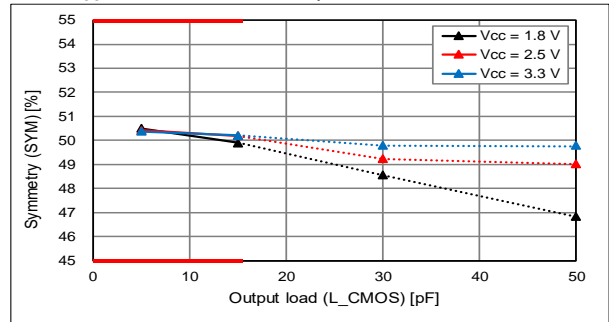

\* Output load condition under L<sub>CMOS</sub> > 15 pF (dotted line area) is not guaranteed, and the data is for reference.

fo = 80 MHz, Rise time/Fall time: A (Default) & B (Fast)

50 %V<sub>CC</sub>, L<sub>CMOS</sub> = 15 pF, Temp. Char.

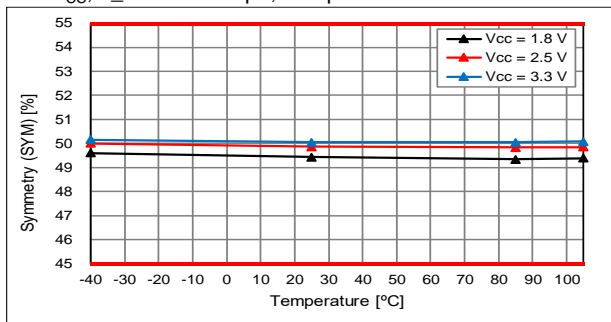

50 %V<sub>CC</sub>, T<sub>use</sub> = +25 °C, Output load Char.

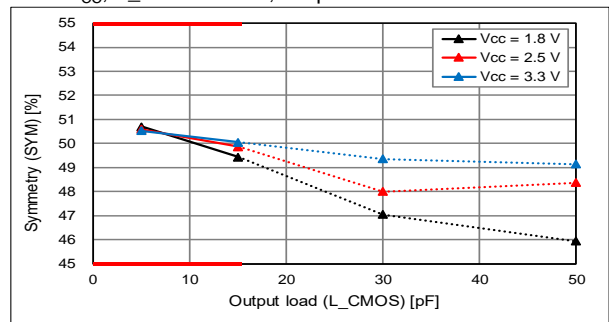

\* Output load condition under L<sub>CMOS</sub> > 15 pF (dotted line area) is not guaranteed, and the data is for reference.

(7-4) Symmetry [cont'd]

fo = 122.88 MHz, Rise time/Fall time: A (Default) & B (Fast)

50 %V<sub>CC</sub>, L<sub>CMOS</sub> = 15 pF, Temp. Char.

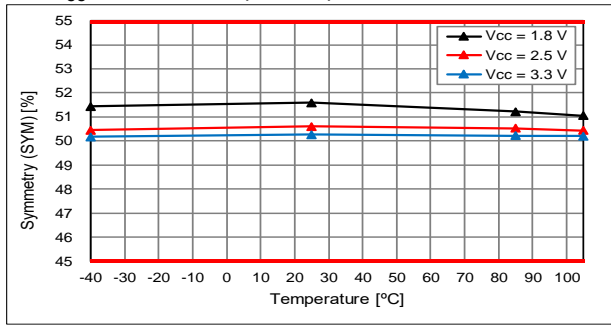

50 %V<sub>CC</sub>, T<sub>use</sub> = +25 °C, Output load Char.

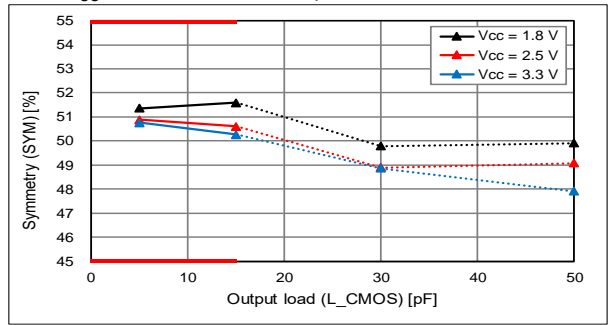

\* Output load condition under L<sub>CMOS</sub> > 15 pF (dotted line area) is not guaranteed, and the data is for reference.

fo = 170 MHz, Rise time/Fall time: A (Default) & B (Fast)

50 %V<sub>CC</sub>, L<sub>CMOS</sub> = 15 pF, Temp. Char.

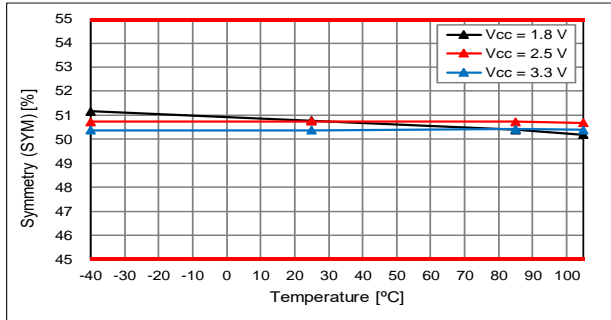

50 %V<sub>CC</sub>, T<sub>use</sub> = +25 °C, Output load Char.

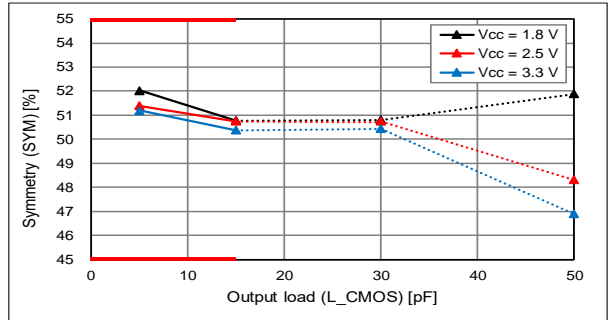

\* Output load condition under L<sub>CMOS</sub> > 15 pF (dotted line area) is not guaranteed, and the data is for reference.

(7-5) Output Voltage

(1) Temperature Characteristics

$V_{OH}$ ,  $L_{CMOS} = 15 \text{ pF}$

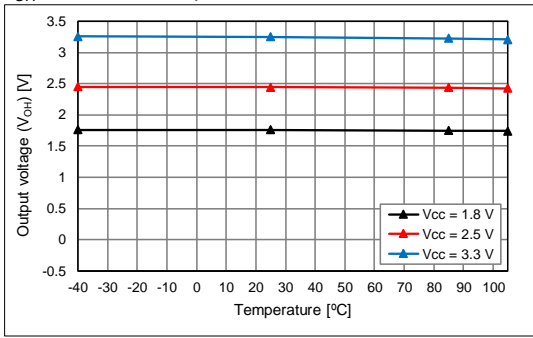

$V_{OL}$ ,  $L_{CMOS} = 15 \text{ pF}$

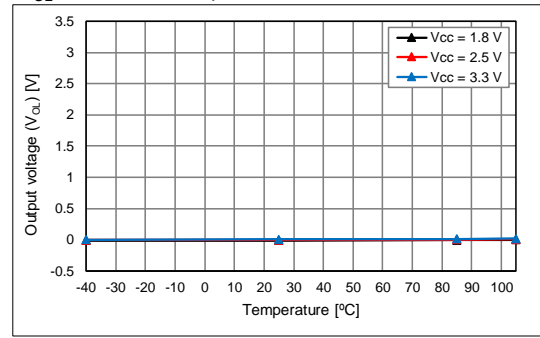

(2) Output Load Characteristics

$f_o = 19.2 \text{ MHz}$ ,  $T_{use} = +25 \text{ °C}$ , Rise time/Fall time: A (Default)

$V_{OH}$

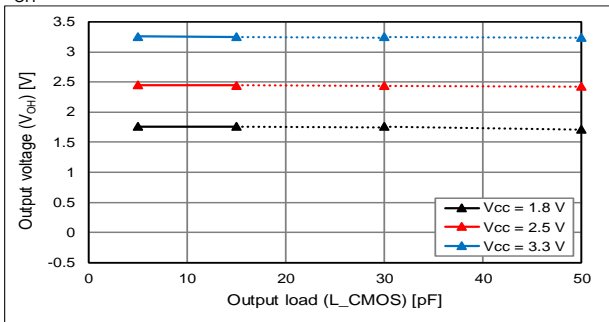

$V_{OL}$

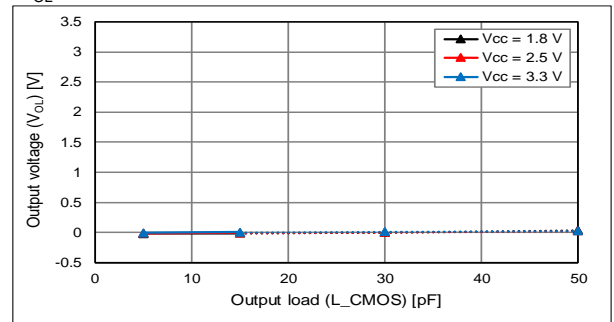

\* Output load condition under  $L_{CMOS} > 15 \text{ pF}$  (dotted line area) is not guaranteed, and the data is for reference.

$f_o = 19.2 \text{ MHz}$ ,  $T_{use} = +25 \text{ °C}$ , Rise time/Fall time: B (Fast)

$V_{OH}$

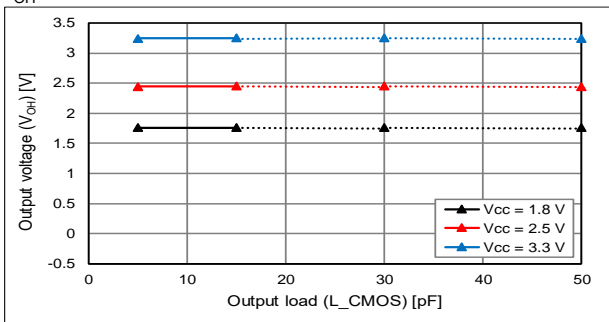

$V_{OL}$

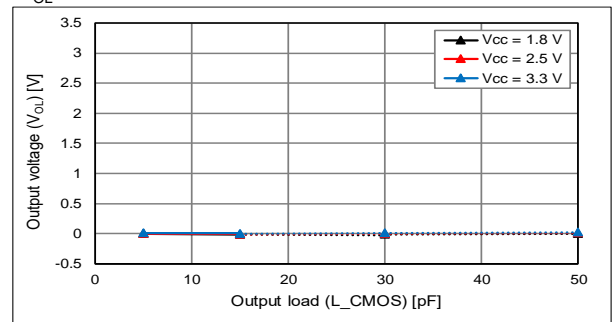

\* Output load condition under  $L_{CMOS} > 15 \text{ pF}$  (dotted line area) is not guaranteed, and the data is for reference.

$f_o = 19.2 \text{ MHz}$ ,  $T_{use} = +25 \text{ °C}$ , Rise time/Fall time: C (Slow)

$V_{OH}$

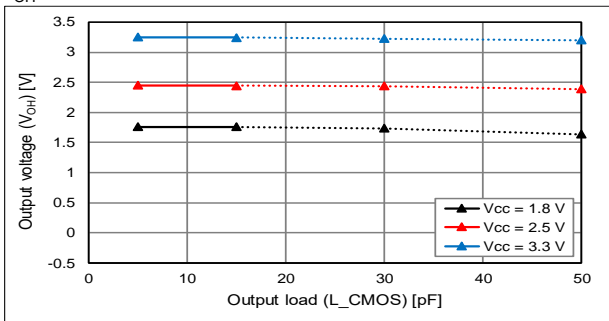

$V_{OL}$

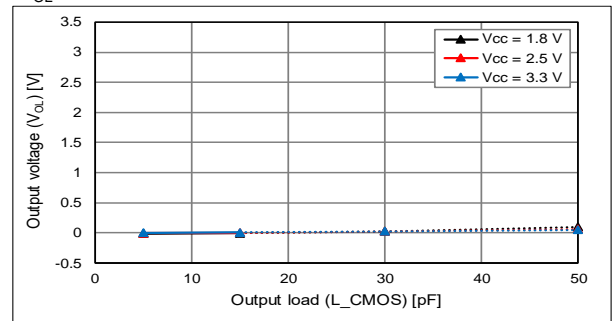

\* Output load condition under  $L_{CMOS} > 15 \text{ pF}$  (dotted line area) is not guaranteed, and the data is for reference.



(7-5) Output Voltage [cont'd]

(2) Output Load Characteristics

fo = 40 MHz, T\_use = +25 °C, Rise time/Fall time: A (Default)

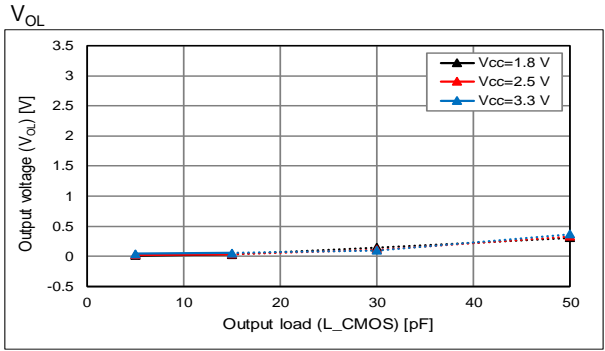
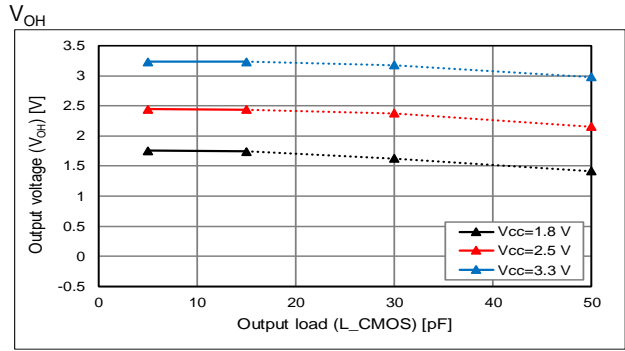

\* Output load condition under L<sub>CMOS</sub> > 15 pF (dotted line area) is not guaranteed, and the data is for reference.

fo = 40 MHz, T\_use = +25 °C, Rise time/Fall time: B (Fast)

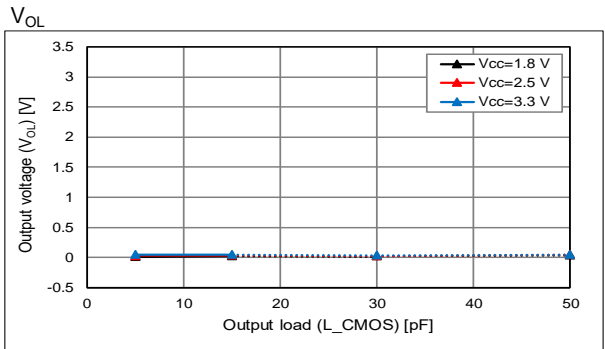
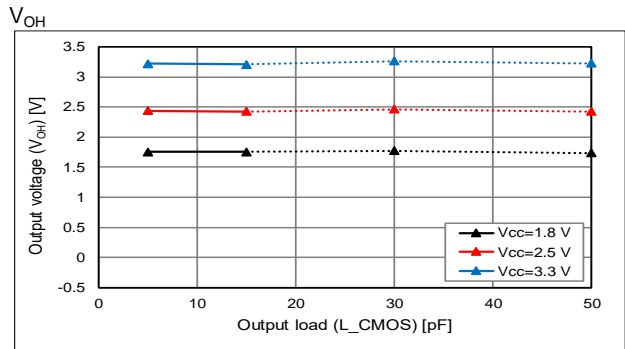

\* Output load condition under L<sub>CMOS</sub> > 15 pF (dotted line area) is not guaranteed, and the data is for reference.

fo = 60 MHz, T\_use = +25 °C, Rise time/Fall time: A (Default) & B (Fast)

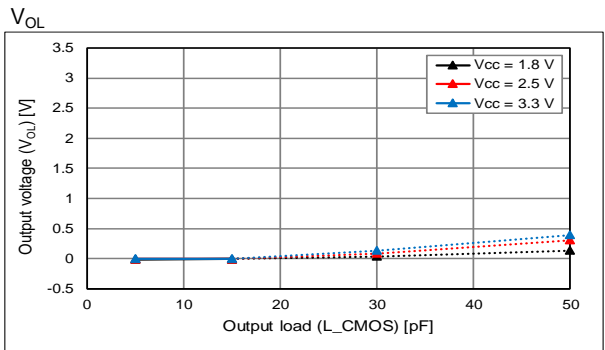
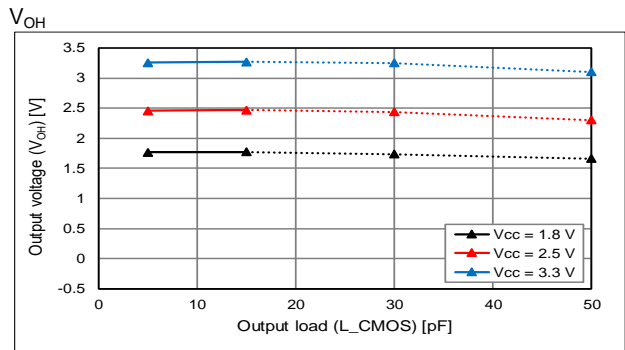

\* Output load condition under L<sub>CMOS</sub> > 15 pF (dotted line area) is not guaranteed, and the data is for reference.

fo = 80 MHz, T\_use = +25 °C, Rise time/Fall time: A (Default) & B (Fast)

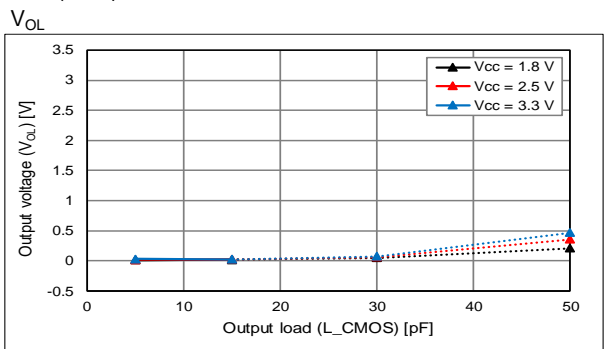
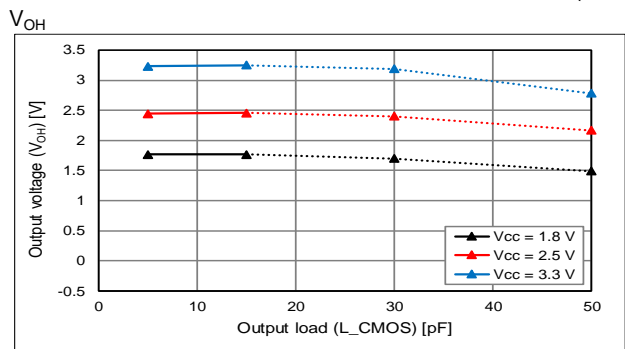

\* Output load condition under L<sub>CMOS</sub> > 15 pF (dotted line area) is not guaranteed, and the data is for reference.

(7-5) Output Voltage [cont'd]

(2) Output Load Characteristics

fo = 122.88 MHz, T\_use = +25 °C, Rise time/Fall time: A (Default) & B (Fast)

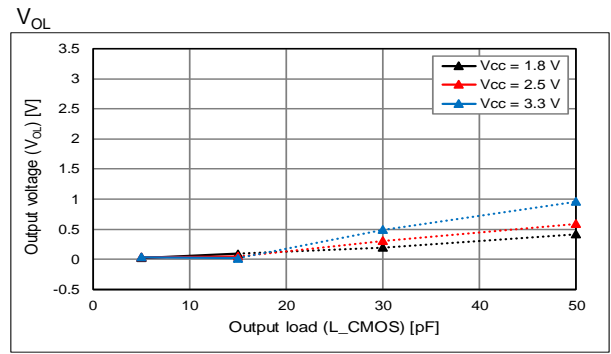
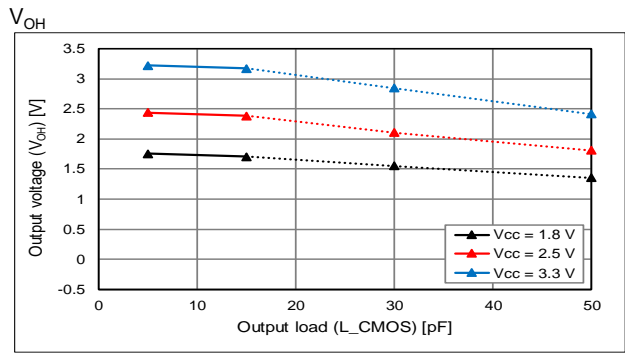

\* Output load condition under L\_CMOS > 15 pF (dotted line area) is not guaranteed, and the data is for reference.

fo = 170 MHz, T\_use = +25 °C, Rise time/Fall time: A (Default) & B (Fast)

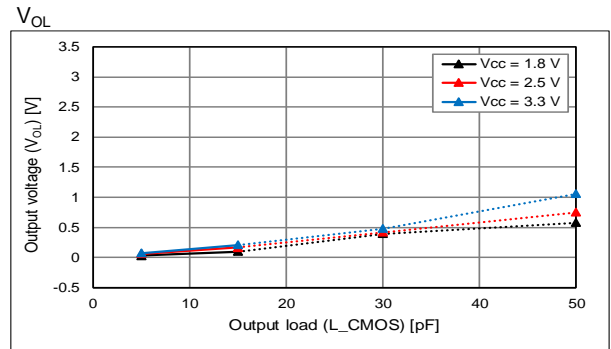
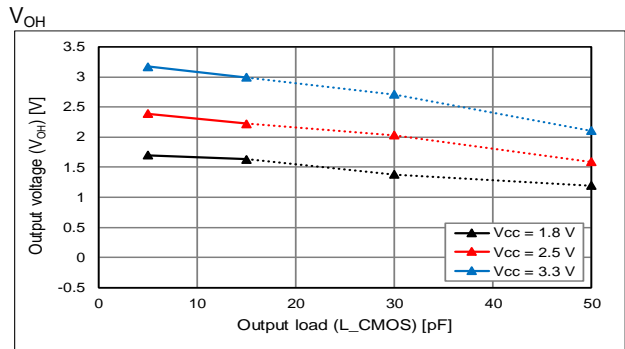

\* Output load condition under L\_CMOS > 15 pF (dotted line area) is not guaranteed, and the data is for reference.

(7-6) Jitter

Cycle to Cycle Jitter, T\_use = +25 °C, Rise time/Fall time: A (Default)

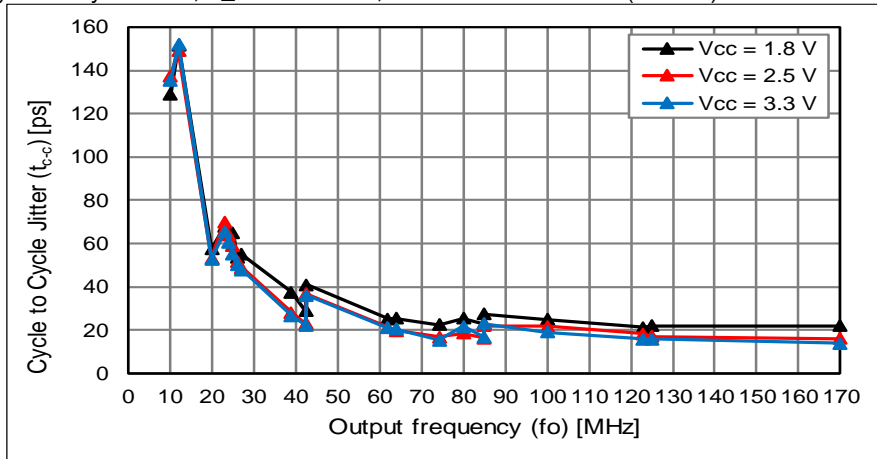

(7-7) Output waveform

fo = 19.2 MHz, Rise time/Fall time: A (Default)

V<sub>CC</sub> = 3.3 V, L<sub>CMOS</sub> = 15 pF, T<sub>use</sub> = +25 °C

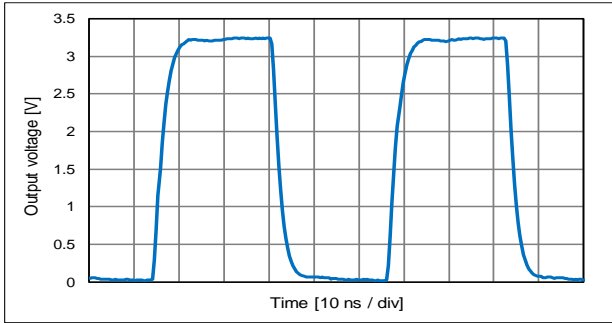

V<sub>CC</sub> = 2.5 V, L<sub>CMOS</sub> = 15 pF, T<sub>use</sub> = +25 °C

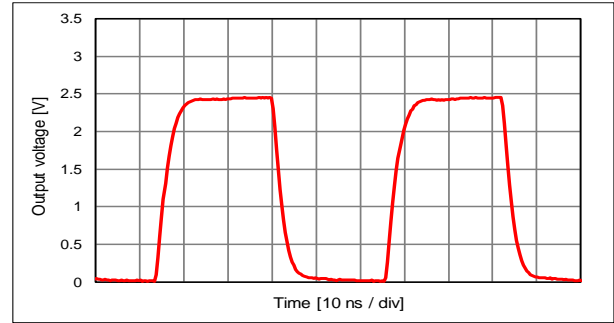

V<sub>CC</sub> = 1.8 V, L<sub>CMOS</sub> = 15 pF, T<sub>use</sub> = +25 °C

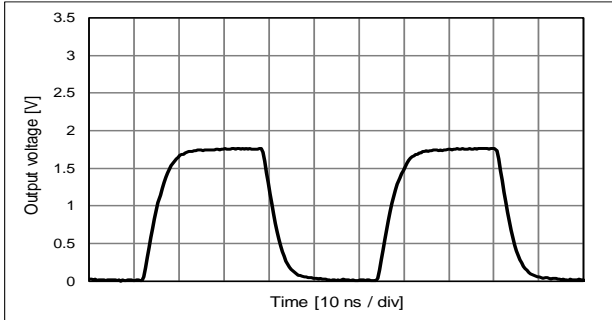

fo = 19.2 MHz, Rise time/Fall time: B (Fast)

V<sub>CC</sub> = 3.3 V, L<sub>CMOS</sub> = 15 pF, T<sub>use</sub> = +25 °C

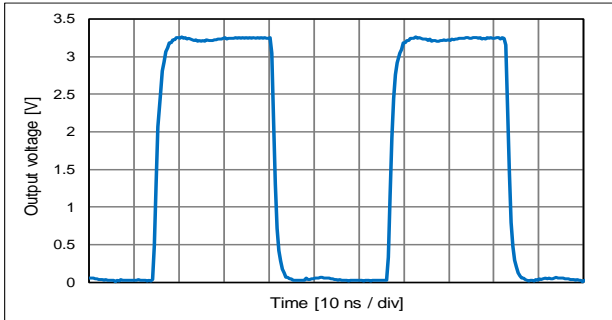

V<sub>CC</sub> = 2.5 V, L<sub>CMOS</sub> = 15 pF, T<sub>use</sub> = +25 °C

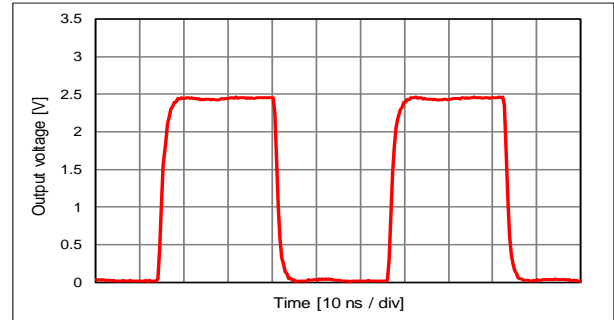

V<sub>CC</sub> = 1.8 V, L<sub>CMOS</sub> = 15 pF, T<sub>use</sub> = +25 °C

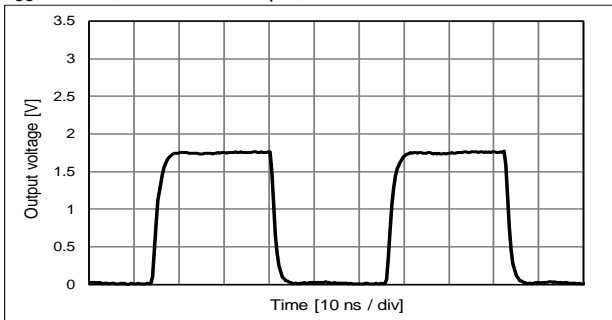

(7-7) Output Waveform [cont'd]

$f_o = 19.2 \text{ MHz}$ , Rise time/Fall time: C (Slow)

$V_{CC} = 3.3 \text{ V}$ ,  $L_{CMOS} = 15 \text{ pF}$ ,  $T_{use} = +25 \text{ }^\circ\text{C}$

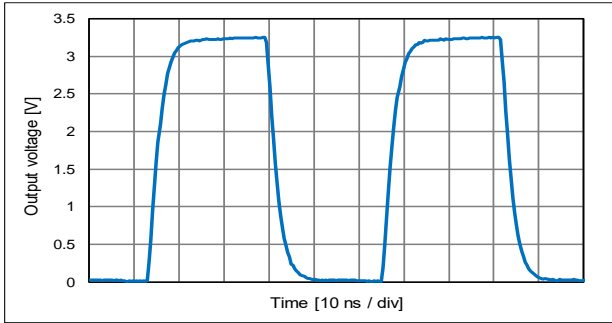

$V_{CC} = 2.5 \text{ V}$ ,  $L_{CMOS} = 15 \text{ pF}$ ,  $T_{use} = +25 \text{ }^\circ\text{C}$

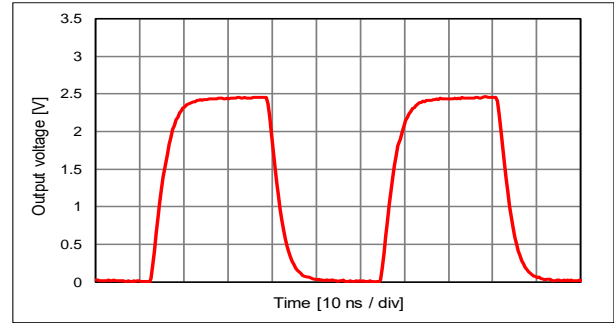

$V_{CC} = 1.8 \text{ V}$ ,  $L_{CMOS} = 15 \text{ pF}$ ,  $T_{use} = +25 \text{ }^\circ\text{C}$

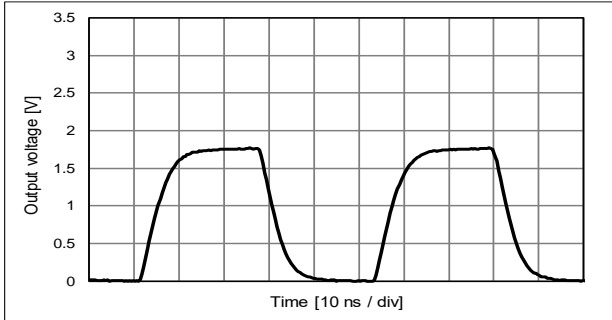

$f_o = 40 \text{ MHz}$ , Rise time/Fall time: A (Default)

$V_{CC} = 3.3 \text{ V}$ ,  $L_{CMOS} = 15 \text{ pF}$ ,  $T_{use} = +25 \text{ }^\circ\text{C}$

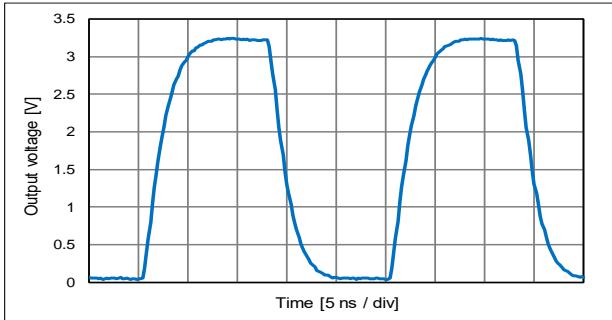

$V_{CC} = 2.5 \text{ V}$ ,  $L_{CMOS} = 15 \text{ pF}$ ,  $T_{use} = +25 \text{ }^\circ\text{C}$

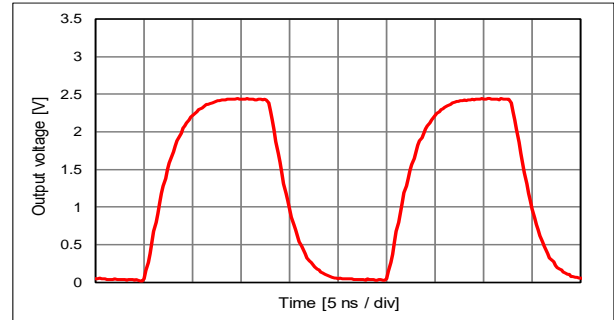

$V_{CC} = 1.8 \text{ V}$ ,  $L_{CMOS} = 15 \text{ pF}$ ,  $T_{use} = +25 \text{ }^\circ\text{C}$

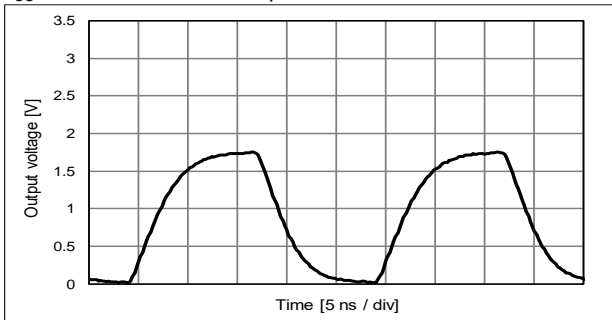

## (7-7) Output Waveform [cont'd]

fo = 40 MHz, Rise time/Fall time: B (Fast)

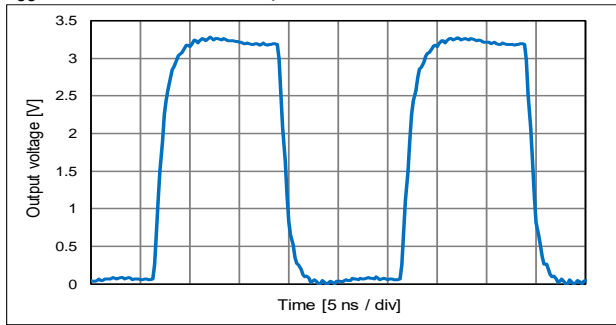
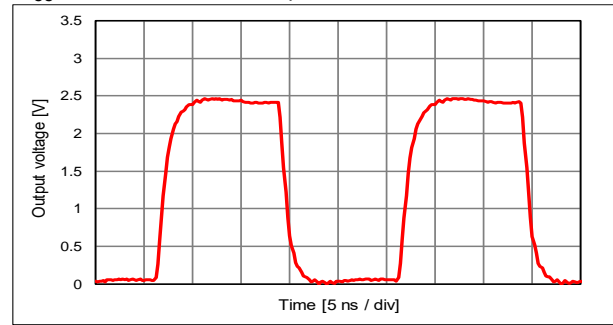
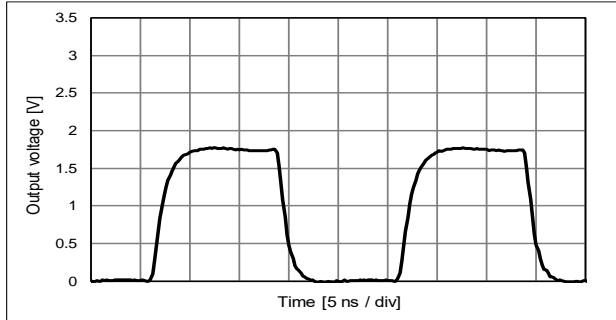
V<sub>CC</sub> = 3.3 V, L<sub>CMOS</sub> = 15 pF, T<sub>use</sub> = +25 °CV<sub>CC</sub> = 2.5 V, L<sub>CMOS</sub> = 15 pF, T<sub>use</sub> = +25 °CV<sub>CC</sub> = 1.8 V, L<sub>CMOS</sub> = 15 pF, T<sub>use</sub> = +25 °C

fo = 60 MHz, Rise time/Fall time: A (Default) &amp; B (Fast)

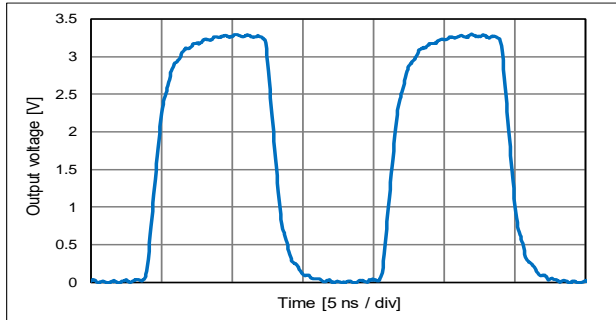
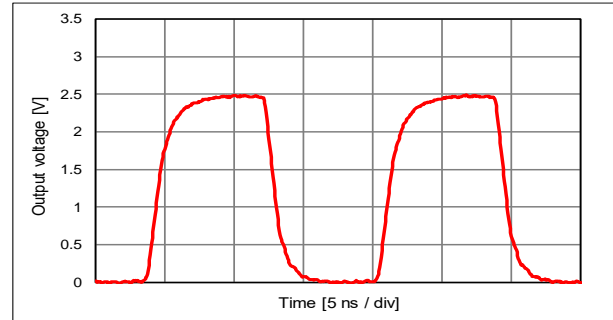
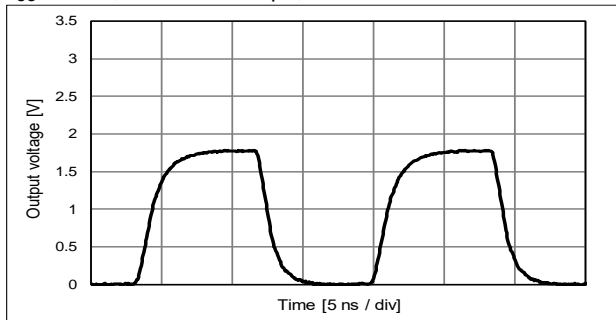
V<sub>CC</sub> = 3.3 V, L<sub>CMOS</sub> = 15 pF, T<sub>use</sub> = +25 °CV<sub>CC</sub> = 2.5 V, L<sub>CMOS</sub> = 15 pF, T<sub>use</sub> = +25 °CV<sub>CC</sub> = 1.8 V, L<sub>CMOS</sub> = 15 pF, T<sub>use</sub> = +25 °C

## (7-7) Output Waveform [cont'd]

fo = 80 MHz, Rise time/Fall time: A (Default) &amp; B (Fast)

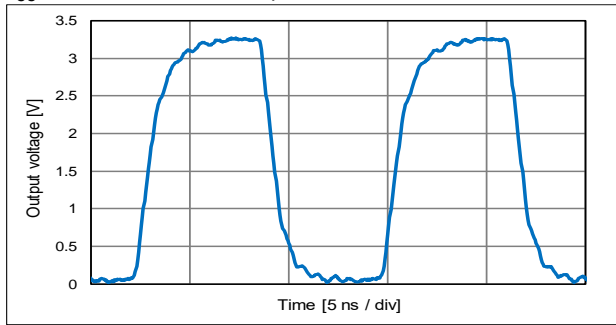
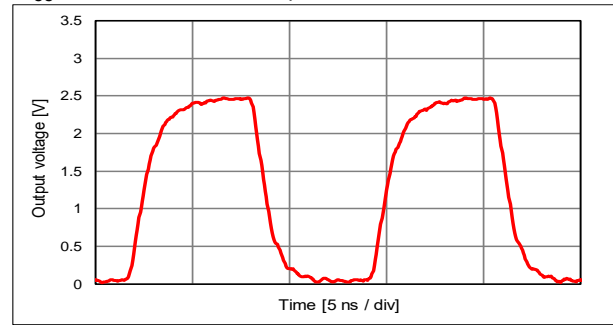
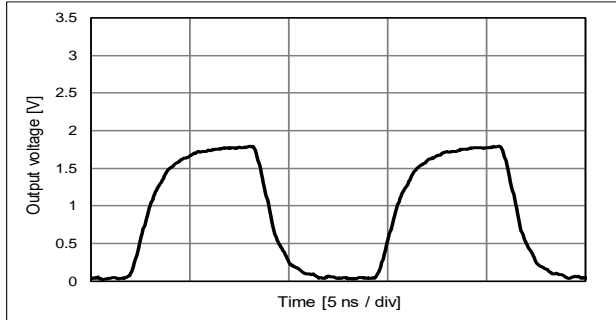
V<sub>CC</sub> = 3.3 V, L<sub>CMOS</sub> = 15 pF, T<sub>use</sub> = +25 °CV<sub>CC</sub> = 2.5 V, L<sub>CMOS</sub> = 15 pF, T<sub>use</sub> = +25 °CV<sub>CC</sub> = 1.8 V, L<sub>CMOS</sub> = 15 pF, T<sub>use</sub> = +25 °C

fo = 122.88 MHz, Rise time/Fall time: A (Default) &amp; B (Fast)

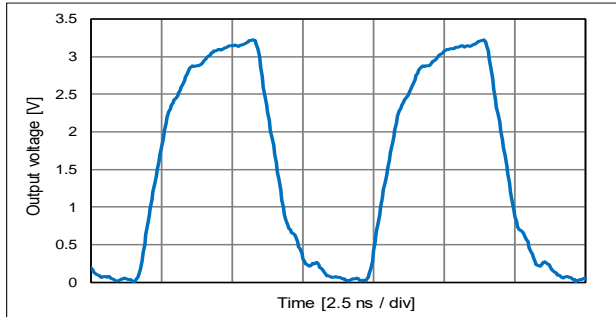
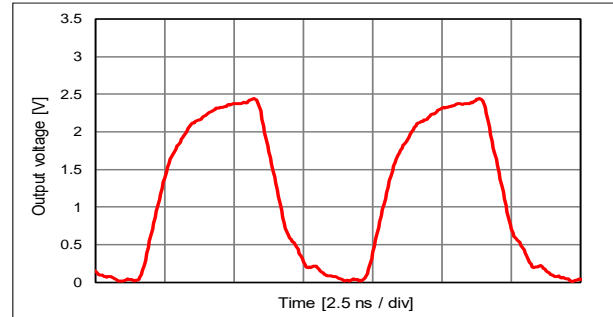
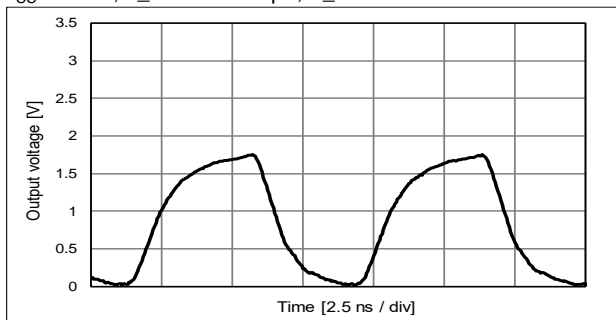
V<sub>CC</sub> = 3.3 V, L<sub>CMOS</sub> = 15 pF, T<sub>use</sub> = +25 °CV<sub>CC</sub> = 2.5 V, L<sub>CMOS</sub> = 15 pF, T<sub>use</sub> = +25 °CV<sub>CC</sub> = 1.8 V, L<sub>CMOS</sub> = 15 pF, T<sub>use</sub> = +25 °C

(7-7) Output Waveform [cont'd]

fo = 170 MHz, Rise time/Fall time: A (Default) & B (Fast)

V<sub>CC</sub> = 3.3 V, L<sub>CMOS</sub> = 15 pF, T<sub>use</sub> = +25 °C

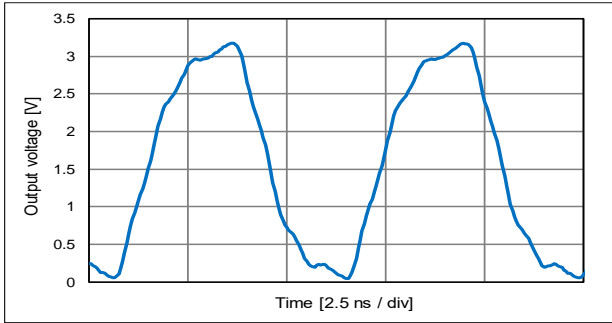

V<sub>CC</sub> = 2.5 V, L<sub>CMOS</sub> = 15 pF, T<sub>use</sub> = +25 °C

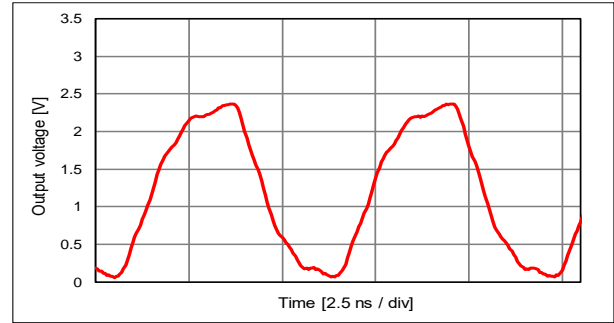

V<sub>CC</sub> = 1.8 V, L<sub>CMOS</sub> = 15 pF, T<sub>use</sub> = +25 °C

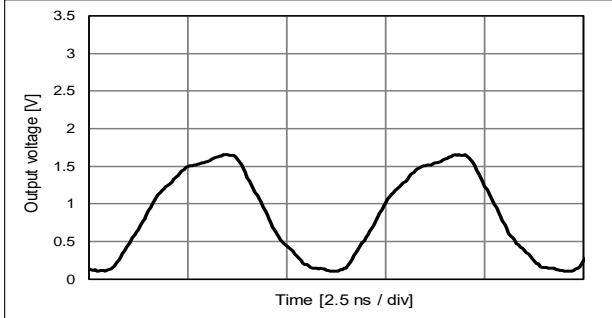

(7-8) Spread Profile and Output Spectrum

fo = 170 MHz, Spread width: ±2.0 %, Modulation frequency: 25.4 kHz

Hershey-kiss (default)

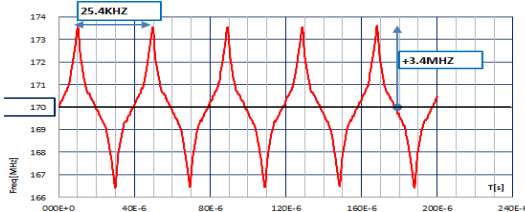

Peak: -20 dB

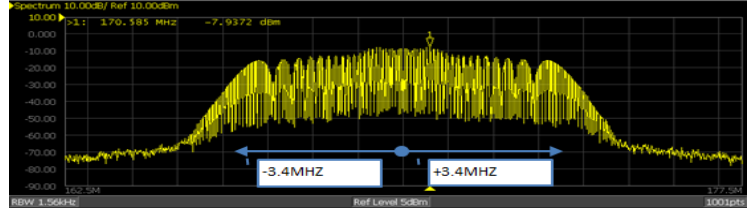

Sine-wave

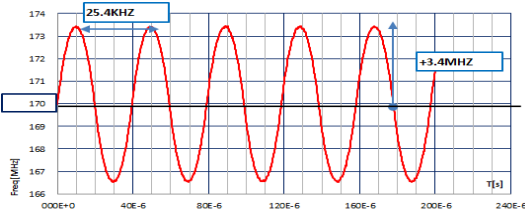

Peak: -17 dB

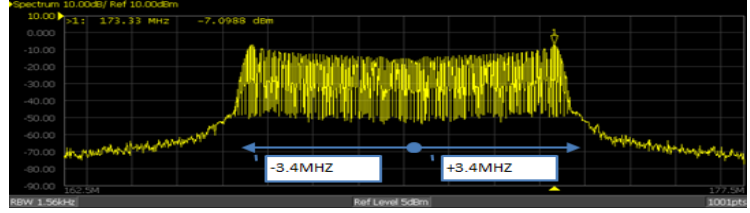

Triangle

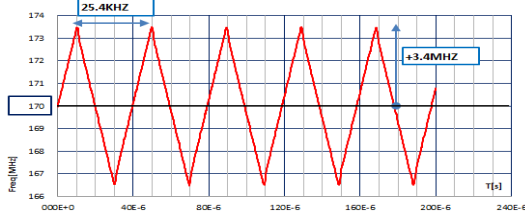

Peak: -21 dB \*

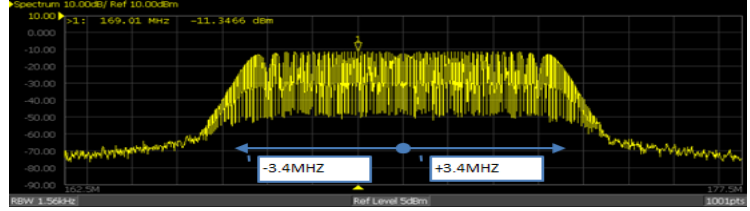

\* Triangle profile has the lowest output spectrum

(7-9) Spread width and Output Spectrum

fo = 170 MHz, Spread profile: Triangle, Modulation frequency: 25.4 kHz

Spread width: ±2.0 %

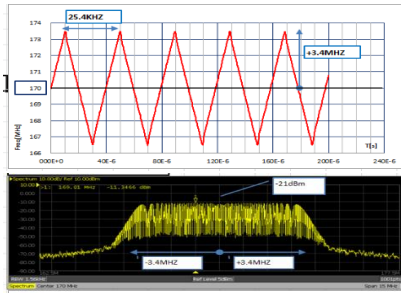

Peak: -21 dB \*

Spread width: ±1.5 %

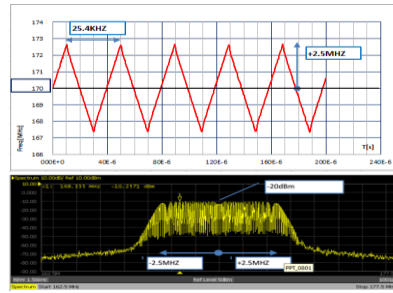

Peak: -20 dB

Spread width: ±1.0 %

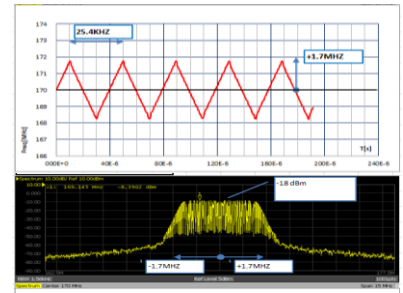

Peak: -18 dB

Spread width: ±0.75 %

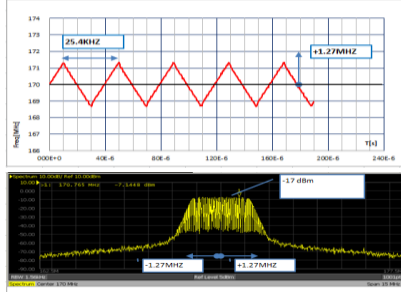

Peak: -17 dB

Spread width: ±0.5 %

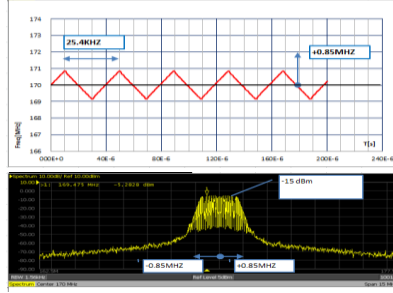

Peak: -15 dB

Spread width: ±0.25 %

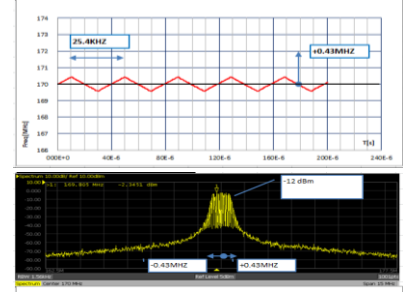

Peak: -12 dB

\* The wider spread width, results in lower output spectrum

(7-10) Modulation Frequency and Output Spectrum

fo = 170 MHz, Spread profile: Triangle, Spread width: ±2.0 %

Modulation freq.: 25.4 kHz

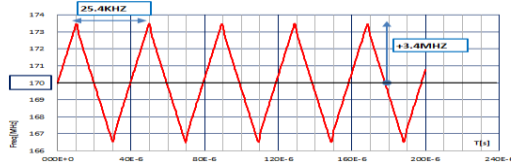

Peak: -21 dB

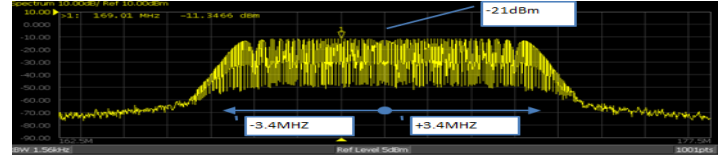

Modulation freq.: 12.7 kHz

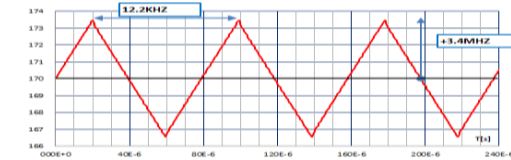

Peak: -24 dB

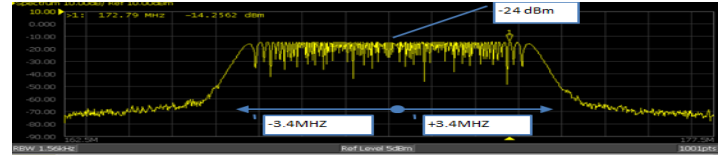

Modulation freq.: 8.5 kHz

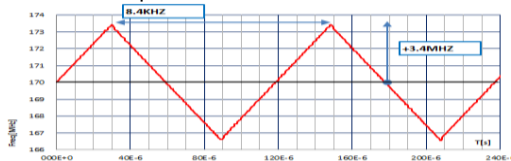

Peak: -25 dB

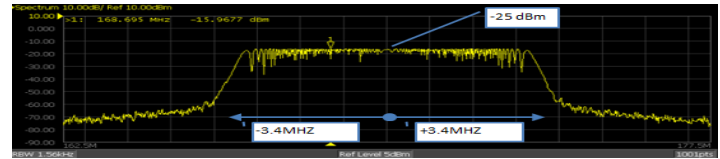

Modulation freq.: 6.3 kHz

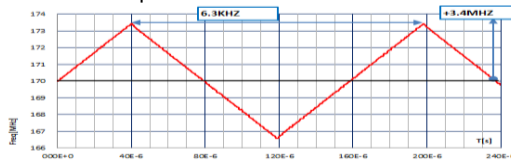

Peak: -27 dB \*

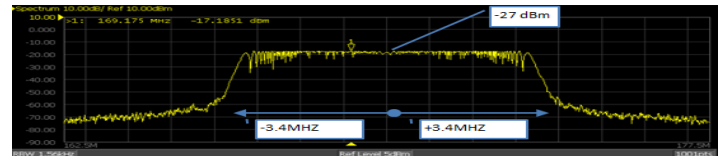

\* The lower modulation frequency, results in lower output spectrum

\* Please also check the Epson web page for SG-9101 series →

[Click here](#)



## [ 8 ] Test Circuit

## (8-1) Waveform Observation

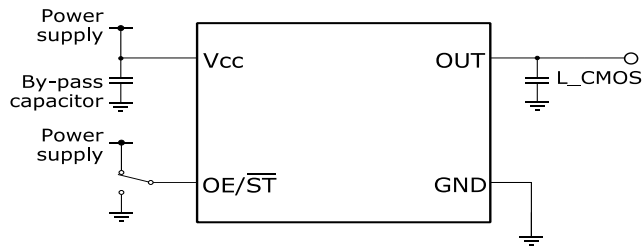

## (8-2) Current Consumption Test

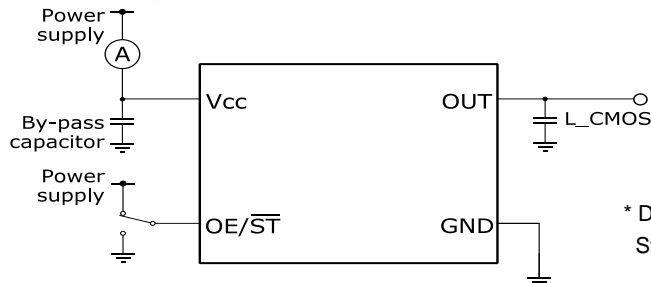

\* Disable current test should be OE = GND.  
Stand-by current test should be  $\overline{ST}$  = GND.

## (8-3) Phase Jitter

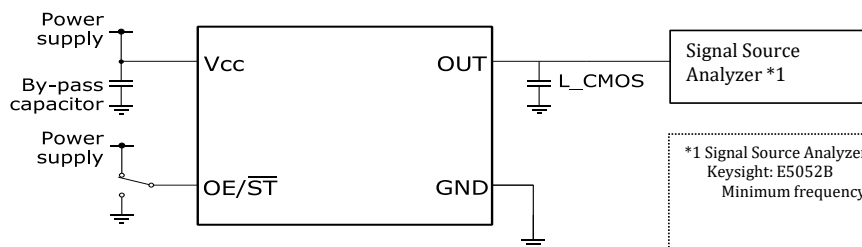

\*1 Signal Source Analyzer  
Keysight: E5052B  
Minimum frequency: 10 MHz

## (8-4) Jitter (Peak to Peak, RMS, Cycle to Cycle)

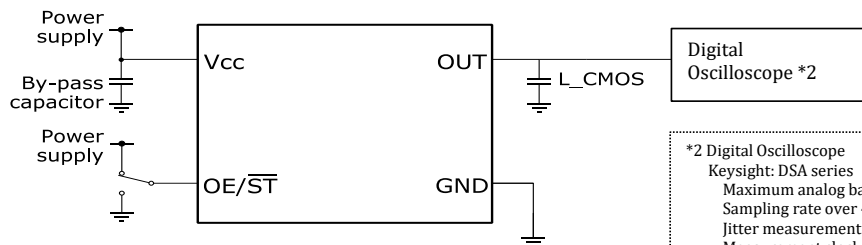

\*2 Digital Oscilloscope  
Keysight: DSA series  
Maximum analog bandwidth to 1 GHz  
Sampling rate over 40 GHz/s  
Jitter measurement software tool: EZJIT+  
Measurement clock cycle > 50 000

## (8-5) Condition

## (1) Oscilloscope

The bandwidth should be minimum 5 times wider than measurement frequency

The probe ground should be placed closely to the test point and the lead length should be as short as possible

\* It is recommended to use miniature socket. (Don't use earth lead.)

## (2) L\_CMOS includes probe capacitance.

(3) A 0.1  $\mu$ F bypass capacitor should be connected between V<sub>CC</sub> and GND pins located close to the device

(4) Use a current meter with a low internal impedance

## (5) Power Supply

Power supply startup time (0 %V<sub>CC</sub> → 90 %V<sub>CC</sub>) should be between 5  $\mu$ s and 500 ms

Power supply impedance should be as low as possible and GND line should be as short as possible

(8-6) Timing Chart

(1) Output Waveform and Level

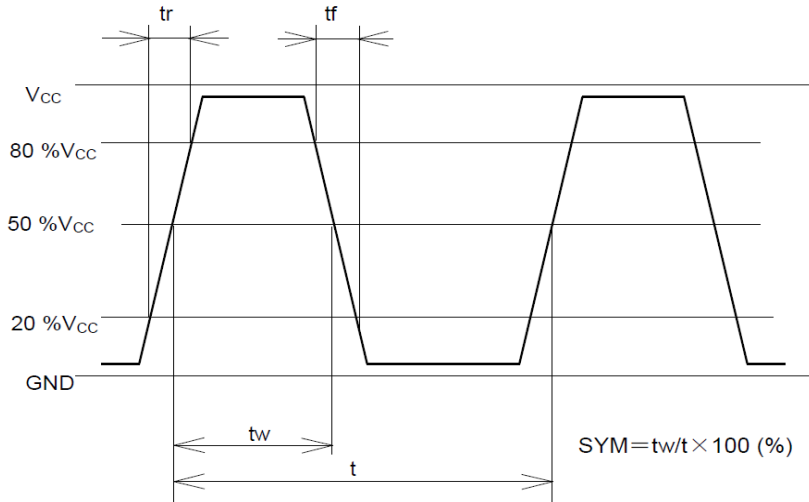

(2) OE/ $\overline{ST}$  Function and Timing

OE/ $\overline{ST}$ terminal	Osc. circuit	Output status
"H"	Oscillation	Specified frequency: Enable
"L"	OE: Oscillation	Low (Weak pull down <sup>*3</sup> ): Disable
	$\overline{ST}$ : Oscillation stop	

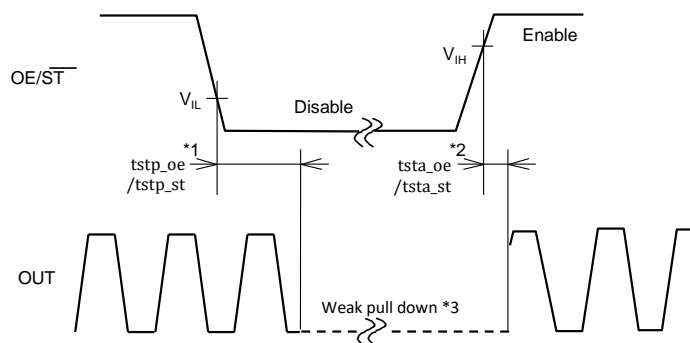

- \*1 The period from OE/ $\overline{ST}$  = V<sub>IL</sub> to OUT = Low (weak pull down) (Disable)
- \*2 The period from OE/ $\overline{ST}$  = V<sub>IH</sub> to OUT = Enable
- \*3 Pulled down with Output pull down resistance (R<sub>DN</sub>)
- \* Judging the start of output when output waveform is observed.
- \* OE/ $\overline{ST}$  terminal voltage level should not exceed supply voltage when using OE/ $\overline{ST}$  function. Please note that OE/ $\overline{ST}$  rise time should not exceed supply voltage rise time at the start-up.
- \* Please do not use the OE/ $\overline{ST}$  terminal in the open state. Typically the output will be enable when OE/ST is open state, but the input pull resistance is large and OE/ $\overline{ST}$  terminal may drop to "L" level and be disable due to noise or leakage current.

## (8-6) Timing Chart [cont'd]

## (3) Spread Profile

## 1) Hershey-kiss

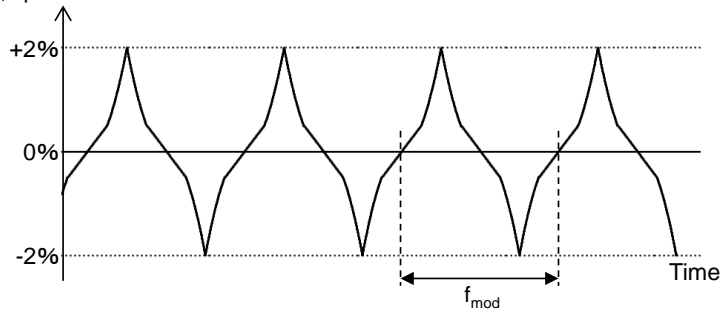
Center spread, spread width:  $\pm 2.0\%$ 

## 2) Sine-wave

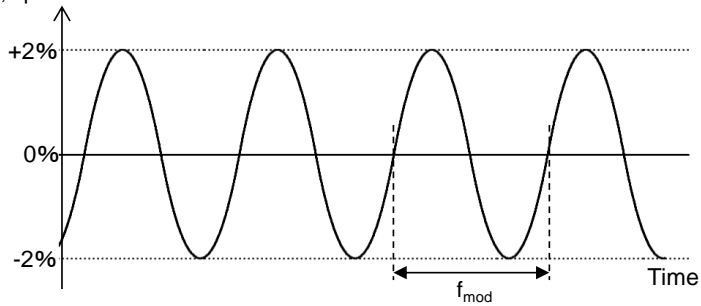
Center spread, spread width:  $\pm 2.0\%$ 

## 3) Triangle

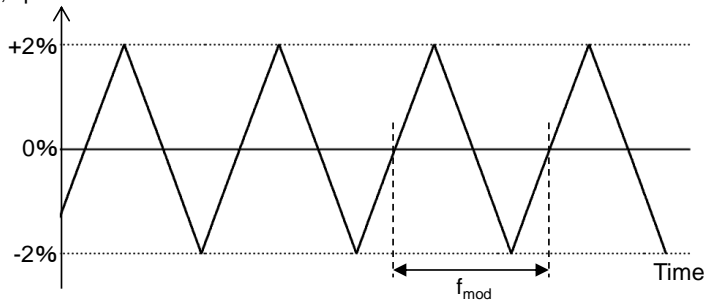
Center spread, spread width:  $\pm 2.0\%$ 

[ 9 ] Outline Drawing and Recommended Footprint  
(9-1) SG-9101CG

Units: mm

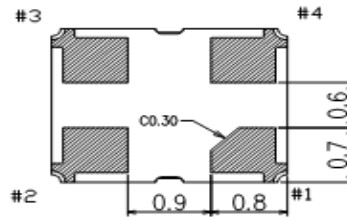
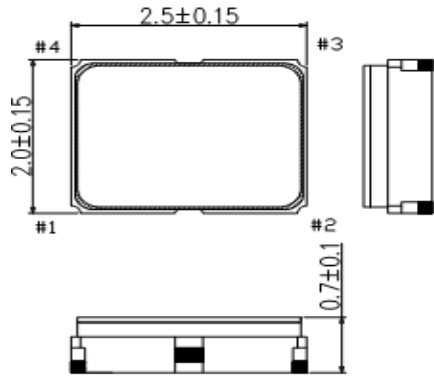

Terminal coating : Au plating

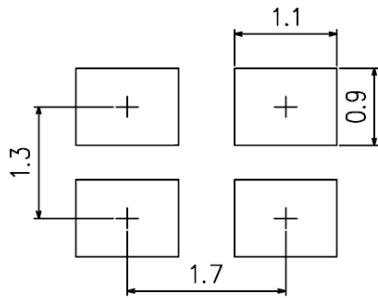

For stable operation, it is recommended that 0.1 μF bypass capacitor should be connected between V<sub>CC</sub> and GND and placed as close to the V<sub>CC</sub> pin as possible.

Reference Weight Typ.: 13 mg

Terminal Assignment

Pin #	Connection	Function		
#1	OE *	OE terminal		
		OE function	Osc. Circuit	Output
		"H"	Oscillation	Specified frequency: Enable
		"L"	Oscillation	Low (weak pull down): Disable
	$\overline{ST}$ *	$\overline{ST}$ terminal		
		$\overline{ST}$ function	Osc. Circuit	Output
"H"		Oscillation	Specified frequency: Enable	
	"L"	Oscillation stop	Low (weak pull down): Disable	
#2	GND	GND terminal		
#3	OUT	Output terminal		
#4	V <sub>CC</sub>	V <sub>CC</sub> terminal		

\* Please do not use the OE/ $\overline{ST}$  terminal in the open state.

Marking

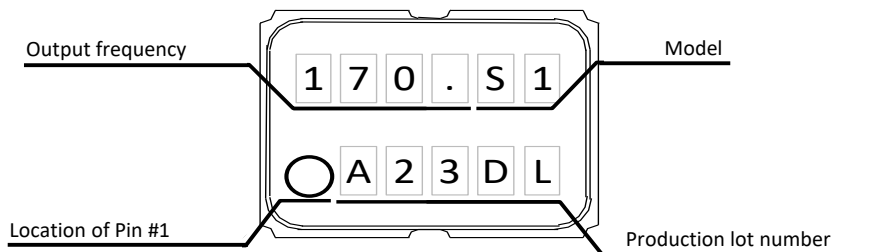

(9-2) SG-9101CE

Units: mm

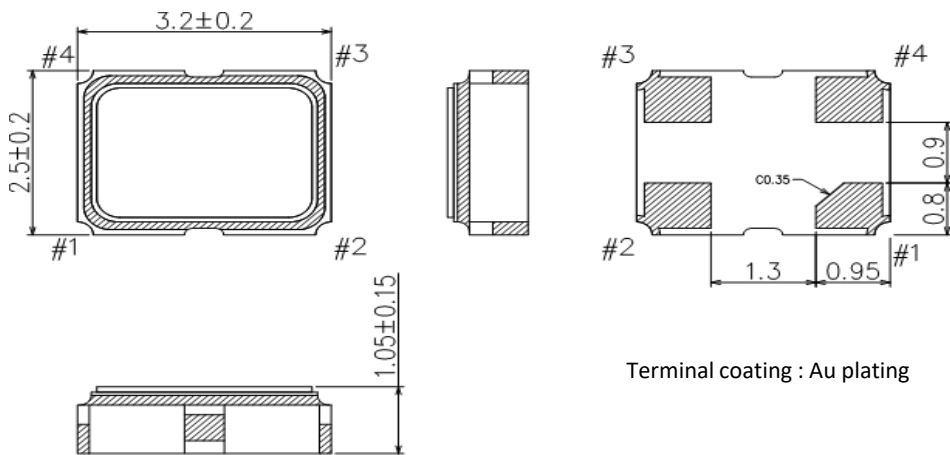

Terminal coating : Au plating

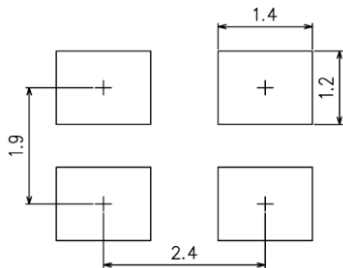

For stable operation, it is recommended that 0.1  $\mu$ F bypass capacitor should be connected between  $V_{CC}$  and GND and placed as close to the  $V_{CC}$  pin as possible.

Reference Weight Typ.: 25 mg

Terminal Assignment

Pin #	Connection	Function		
#1	OE *	OE terminal		
		OE function	Osc. Circuit	Output
		"H"	Oscillation	Specified frequency: Enable
		"L"	Oscillation	Low (weak pull down): Disable
	$\overline{ST}$ *	$\overline{ST}$ terminal		
		$\overline{ST}$ function	Osc. Circuit	Output
"H"		Oscillation	Specified frequency: Enable	
	"L"	Oscillation stop	Low (weak pull down): Disable	
#2	GND	GND terminal		
#3	OUT	Output terminal		
#4	$V_{CC}$	$V_{CC}$ terminal		

\* Please do not use the OE/ $\overline{ST}$  terminal in the open state.

Marking

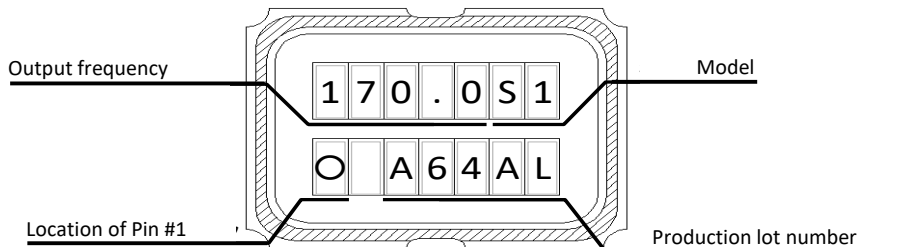

(9-4) SG-9101CB

Units: mm

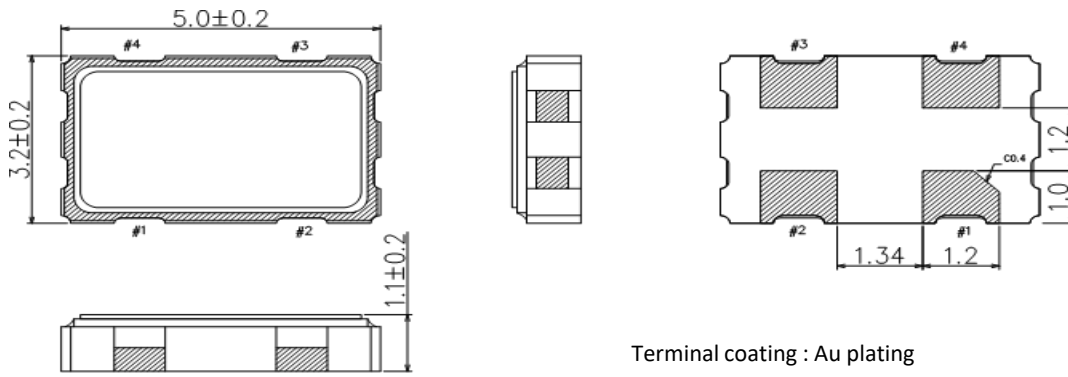

Terminal coating : Au plating

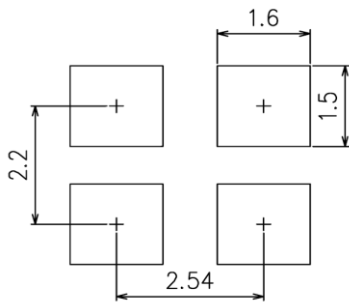

For stable operation, it is recommended that 0.1  $\mu$ F bypass capacitor should be connected between  $V_{CC}$  and GND and placed as close to the  $V_{CC}$  pin as possible.

Reference Weight Typ.: 51 mg

Terminal Assignment

Pin #	Connection	Function		
#1	OE *	OE terminal		
		OE function	Osc. Circuit	Output
		"H"	Oscillation	Specified frequency: Enable
		"L"	Oscillation	Low (weak pull down): Disable
	$\overline{ST}$ *	$\overline{ST}$ terminal		
		$\overline{ST}$ function	Osc. Circuit	Output
"H"		Oscillation	Specified frequency: Enable	
	"L"	Oscillation stop	Low (weak pull down): Disable	
#2	GND	GND terminal		
#3	OUT	Output terminal		
#4	$V_{CC}$	$V_{CC}$ terminal		

\* Please do not use the OE/ $\overline{ST}$  terminal in the open state.

Marking

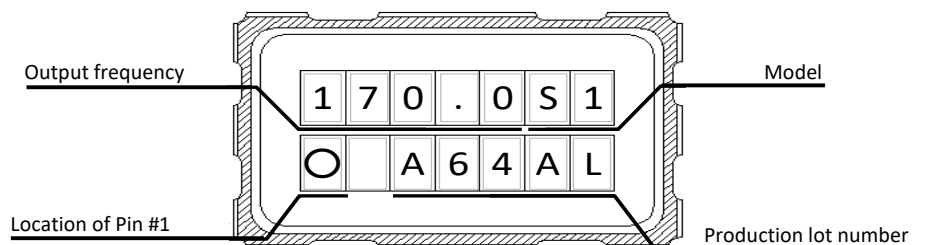

(9-5) SG-9101CA

Units: mm

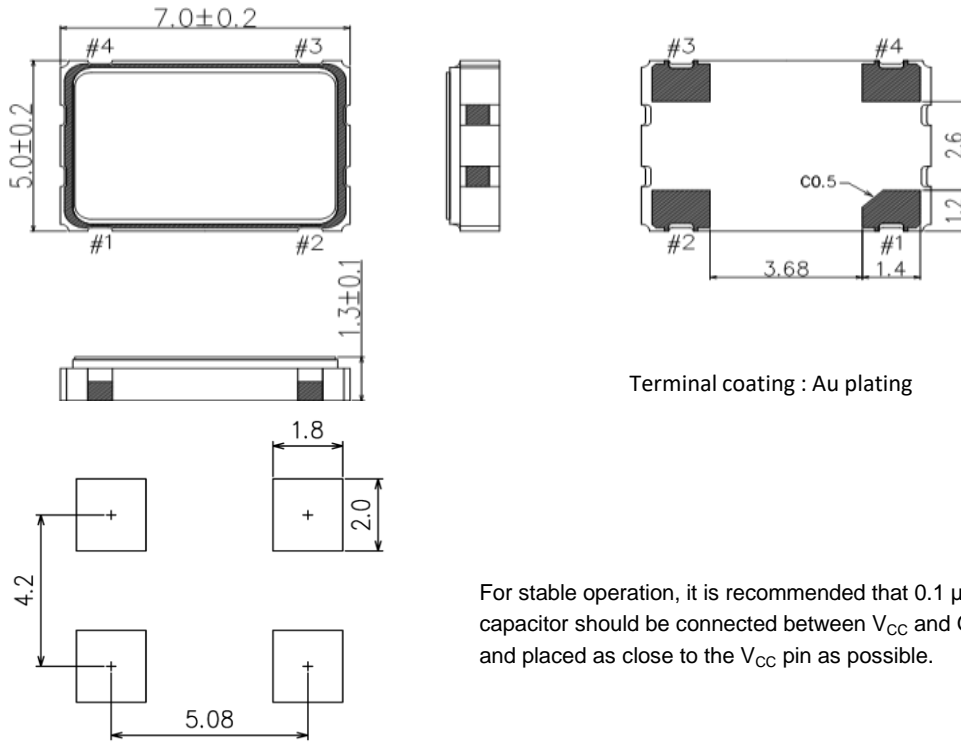

Reference Weight Typ.: 143 mg

Terminal Assignment

Pin #	Connection	Function		
#1	OE *	OE terminal		
		OE function	Osc. Circuit	Output
		"H"	Oscillation	Specified frequency: Enable
		"L"	Oscillation	Low (weak pull down): Disable
	ST *	ST terminal		
		ST function	Osc. Circuit	Output
"H"		Oscillation	Specified frequency: Enable	
	"L"	Oscillation stop	Low (weak pull down): Disable	
#2	GND	GND terminal		
#3	OUT	Output terminal		
#4	V <sub>CC</sub>	V <sub>CC</sub> terminal		

\* Please do not use the OE/ST terminal in the open state.

Marking

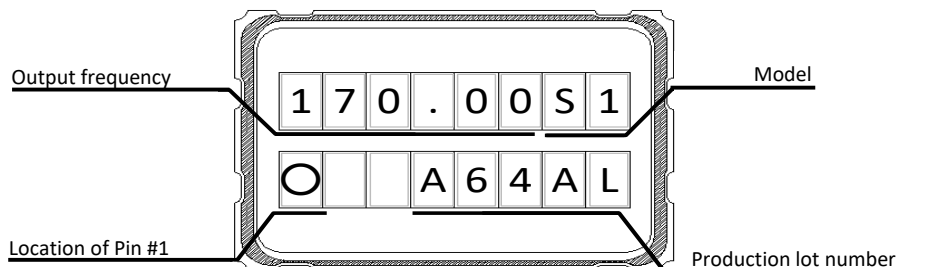

## [ 10 ] Moisture Sensitivity Level

Parameter	Specification	Conditions
MSL	LEVEL 1	IPC/JEDEC J-STD-020D.1

## [ 11 ] Reflow Profiles

IPC/JEDEC J-STD-020D.1

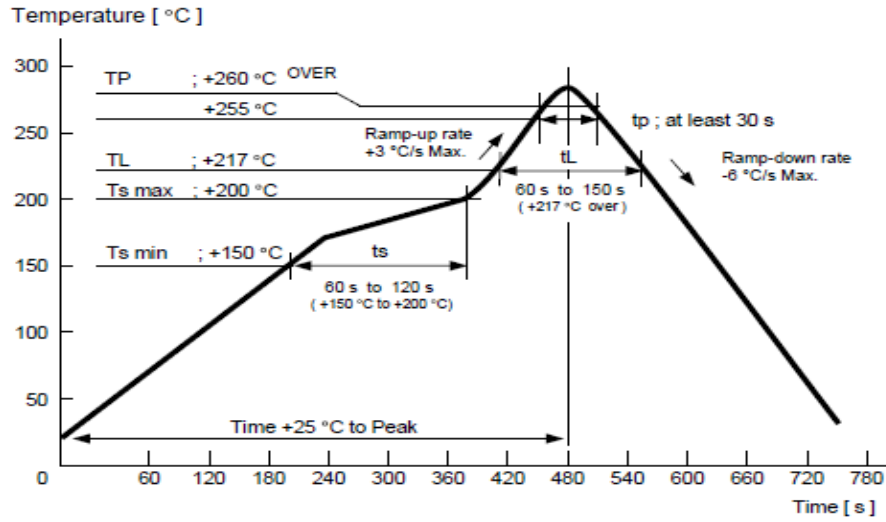



[ 12 ] Packing Information

(12-1) SG-9101CG

(1) Packing Quantity

The last two digits of the Product Number (X1G005291xxxxxx) are a code that defines the packing quantity. The standard is "00" for a 3 000 pcs/Reel.

(2) Taping Specification

Subject to EIA-481, IEC-60286 and JIS C0806

1) Tape Dimensions

Carrier Tape Material: PS (Polystyrene)

Top Tape Material: PET (Polyethylene Terephthalate) + PE (Polyethylene)

Units: mm

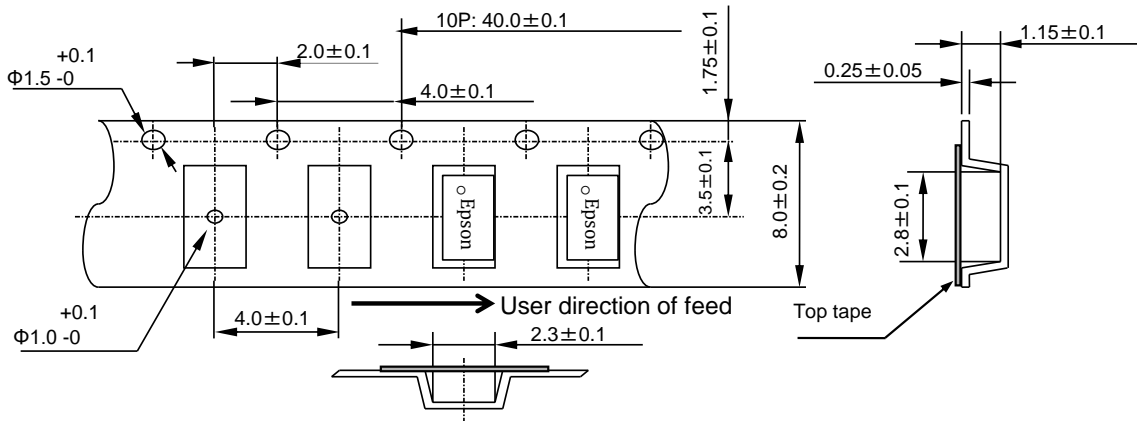

2) Reel Dimensions

Reel Material: PS (Polystyrene)

Units: mm

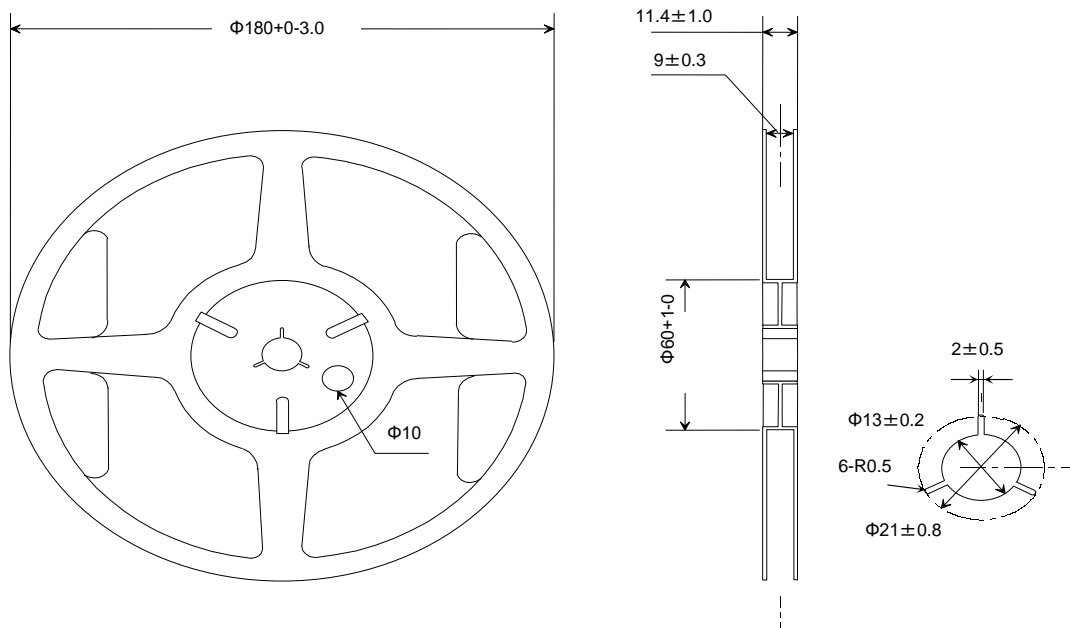

3) Storage Environment

We recommend to keep less than +30 °C and 85 %RH of humidity in a packed condition, and to use it less than 6 months after delivery.

(12-2) SG-9101CE

(1) Packing Quantity

The last two digits of the Product Number (X1G005321xxxxxx) are a code that defines the packing quantity. The standard is "00" for a 2 000 pcs/Reel.

(2) Taping Specification

Subject to EIA-481, IEC-60286 and JIS C0806

1) Tape Dimensions

Carrier Tape Material: PS (Polystyrene)

Top Tape Material: PET (Polyethylene Terephthalate) + PE (Polyethylene)

Units: mm

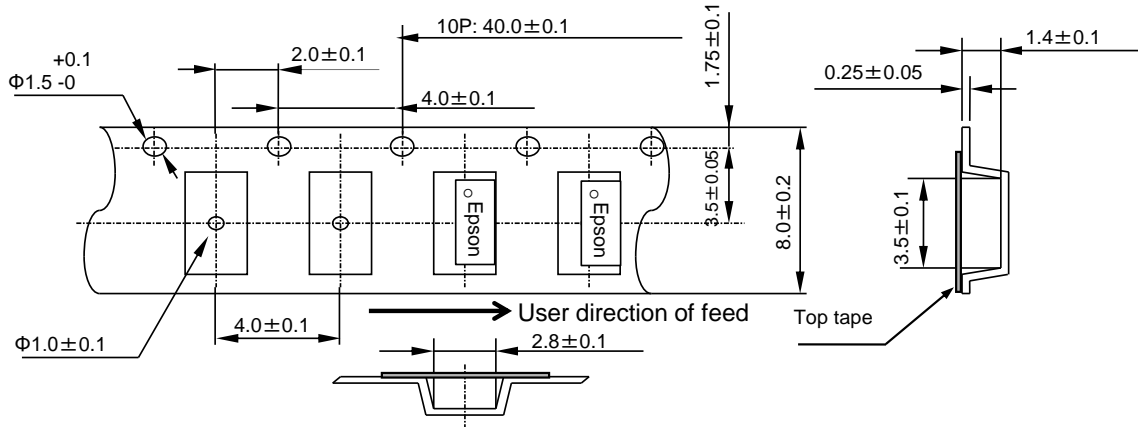

2) Reel Dimensions

Reel Material: PS (Polystyrene)

Units: mm

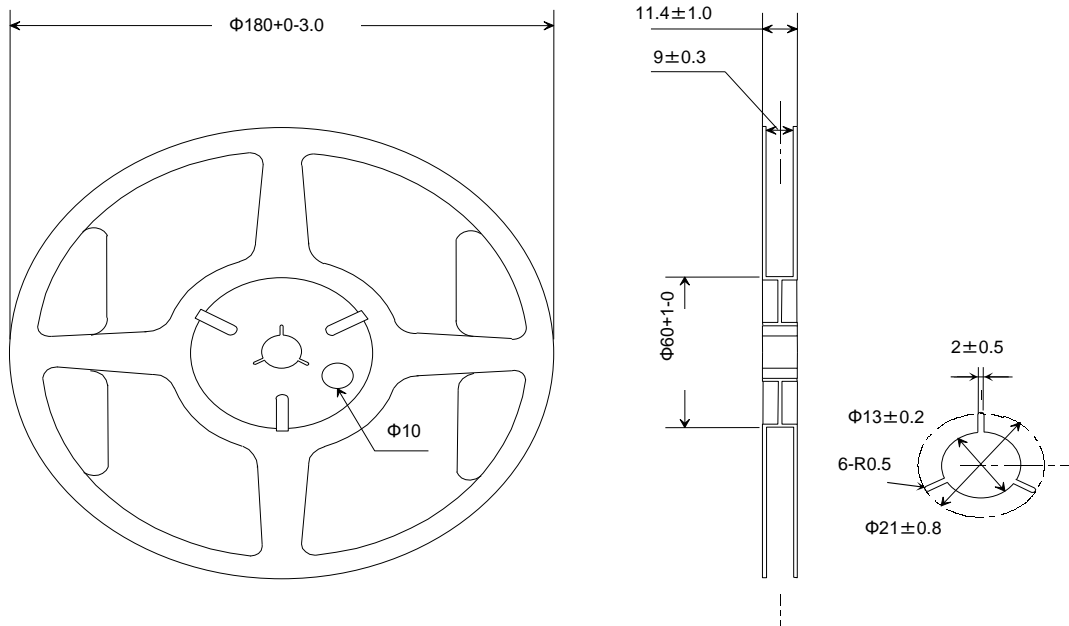

3) Storage Environment

We recommend to keep less than  $+30\text{ }^{\circ}\text{C}$  and 85 %RH of humidity in a packed condition, and to use it less than 6 months after delivery.

## (12-3) SG-9101CB

## (1) Packing Quantity

The last two digits of the Product Number (X1G005311xxxxxx) are a code that defines the packing quantity. The standard is "00" for a 1 000 pcs/Reel.

## (2) Taping Specification

Subject to EIA-481 & IEC-60286

## 1) Tape Dimensions

Carrier Tape Material: PS (Polystyrene)

Top Tape Material: PET (Polyethylene Terephthalate)

Units: mm

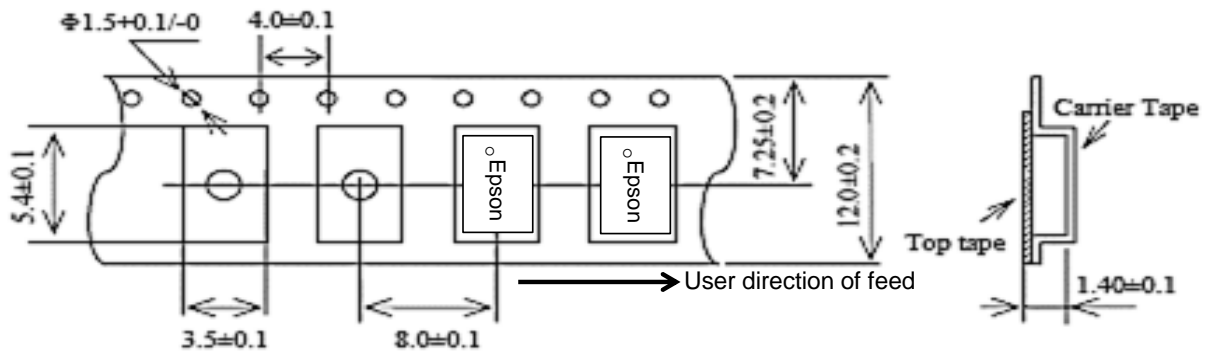

## 2) Reel Dimensions

Reel Material: PS (Polystyrene)

Units: mm

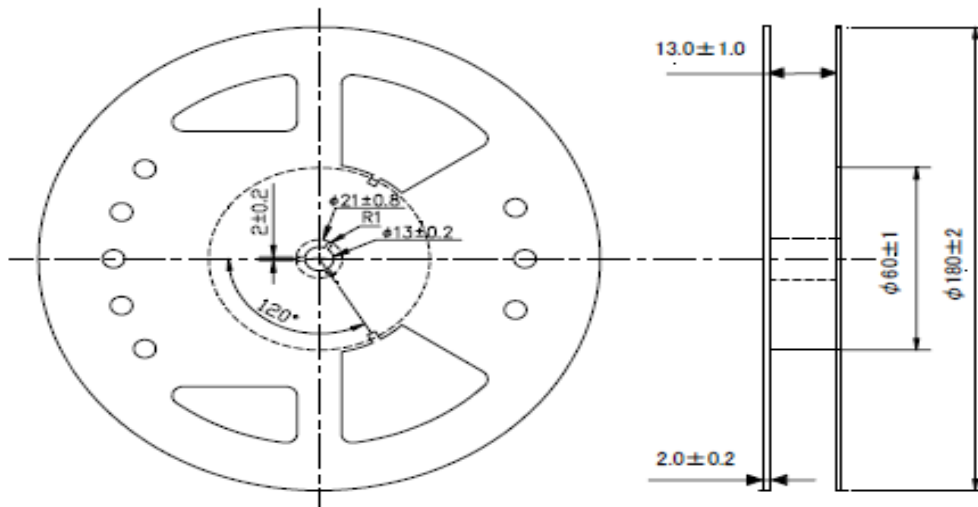

## 3) Storage Environment

We recommend to keep less than  $+30\text{ }^{\circ}\text{C}$  and 85 %RH of humidity in a packed condition, and to use it less than 6 months after delivery.



## [ 13 ] Handling Precautions

Prior to using this product, please carefully read the section entitled "Precautions" on our Web site (<https://www5.epsondevice.com/en/information/#precaution>) for instructions on how to handle and use the product properly to ensure optimal performance of the product in your equipment.

Before using the product under any conditions other than those specified therein, please consult with us to verify and confirm that the performance of the product will not be negatively affected by use under such conditions.

In addition to the foregoing precautions, in order to avoid the deteriorating performance of the product, we strongly recommend that you DO NOT use the product under ANY of the following conditions:

- (1) Do not expose this product to excessive mechanical shock or vibration.
- (2) This product can be damaged by mechanical shock during the soldering process depending on the equipment used, process conditions, and any impact forces experienced. Always follow appropriate procedures, particularly when changing the assembly process in any way and be sure to follow applicable process qualification standards before starting production.
- (3) These devices are sensitive to ESD, use appropriate precautions during handling, assembly, test, shipment, and installation.
- (4) The use of ultrasonic technology for cleaning, bonding, etc. can damage the Xtal unit inside this product. Please carefully check for this consideration before using ultrasonic equipment for volume production with this product.
- (5) Noise and ripple on the power supply may have undesirable effects on operation and cause degradation of phase noise characteristics. Evaluate the operation of this device with appropriate power supplies carefully before use.
- (6) When applying power, ensure that the supply voltage increases monotonically for proper operation. On power down, do not reapply power until the supplies, bypass capacitors, and any bulk capacitors are completely discharged since that may cause the unit to malfunction.
- (7) Aging specifications are estimated from environmental reliability tests and expected frequency variation over time. They do not provide a guarantee of aging over the product lifecycle.
- (8) The metal cap on top of the device is directly connected to the GND terminal (pin #2). Take necessary precautions to prevent any conductor not at ground potential from contacting the cap as that could cause a short circuit to GND.
- (9) Do not route any signal lines, supply voltage lines, or GND lines underneath the area where the oscillators are mounted including any internal layers and on the opposite side of the PCB. To avoid any issues due to interference of other signal lines, please take care not to place signal lines near the product as this may have an adverse affect on the performance of the product.
- (10) A bypass capacitor of the recommended value(s) must be connected between the V<sub>CC</sub> and GND terminals of the product. Whenever possible, mount the capacitor(s) on the same side of the PCB and as close to the product as possible to keep the routing traces short.
- (11) Power supply connections to V<sub>CC</sub> and GND pins should be routed as thick as possible while keeping the high frequency impedance low in order to get the best performance.
- (12) The use of a filter or similar element in series with the power supply connections to protect from electromagnetic radiation noise may increase the high frequency impedance of the power supply line and may cause the oscillator to not operate properly. Please verify the design to ensure sufficient operational margin prior to use.
- (13) Keep PCB routing from the output terminal(s) to the load as short as possible for best performance.
- (14) The Enable (OE or  $\overline{ST}$ ) input terminal is high impedance and so susceptible to noise. Connect it to a low impedance source when used and when not used it is recommended to connect it to V<sub>CC</sub> for active high inputs and GND for active low inputs.
- (15) Do not short the output to GND as that will damage the product. Always use with an appropriate load resistor connected.
- (16) This product should be reflowed no more than 3 times.  
If rework is needed after reflow, please correct it with a soldering iron with the tip set for a temperature of +350 °C or less and only contact each terminal once and for no more than 5 seconds.  
If this product is mounted on the bottom of the board during a reflow please check that it soldered down properly afterwards.

## [Availability of mounting conditions]

Reflow on the board	Available
Reflow under the board	The parts may fall. Please judge whether it is possible to implement.
Soldering pot/bath (Dip soldering system, Flow soldering system)	<b>Not Available</b>
Soldering iron	Available

- (17) Product failures during the warranty period only apply when the product is used according to the recommended operating conditions described in the specifications. Products that have been opened for analysis or damaged will not be covered. It is recommended to store and use in normal temperature and humidity environments described in the specifications to ensure frequency accuracy and prevent moisture condensation. If the product is stored for more than one year, please confirm the pin solderability prior to use.
- (18) If the oscillation circuit is exposed to condensation, the frequency may change or oscillation may stop. Do not use in any conditions where condensation occurs.
- (19) Do not store or use the product in an environment where it can be exposed to chemical substances that are corrosive to metal or plastics such as salt water, organic solvents, chemical gasses, etc. Do not use the product when it is exposed to sunlight, dust, corrosive gasses, or other materials for long periods of time.
- (20) When using water-soluble solder flux make sure to completely remove the flux residue after soldering. Pay particular attention when the residues contain active halogens which will negatively affect the product and its performance.
- (21) Terminals on the side of the product are internally connected to the IC, be careful not to cause short-circuits or reduce the insulation resistance of them in any way.
- (22) Should any customer use the product in any manner contrary to the precautions and/or advice herein, such use shall be done at the customer's own risk.

## PROMOTION OF ENVIRONMENTAL MANAGEMENT SYSTEM CONFORMING TO INTERNATIONAL STANDARDS

At Seiko Epson, all environmental initiatives operate under the Plan-Do-Check-Action (PDCA) cycle designed to achieve continuous improvements. The environmental management system (EMS) operates under the ISO 14001 environmental management standard.

All of our major manufacturing and non-manufacturing sites, in Japan and overseas, completed the acquisition of ISO 14001 certification.



ISO 14000 is an international standard for environmental management that was established by the International Standards Organization in 1996 against the background of growing concern regarding global warming, destruction of the ozone layer, and global deforestation.

## WORKING FOR HIGH QUALITY

In order provide high quality and reliable products and services than meet customer needs, Seiko Epson made early efforts towards obtaining ISO9000 series certification and has acquired ISO9001 for all business establishments in Japan and abroad. We have also acquired IATF 16949 certification that is requested strongly by major manufacturers as standard.

IATF 16949 is the international standard that added the sector-specific supplemental requirements for automotive industry based on ISO9001.

### ■ Explanation of marks used in this datasheet

	<p>●Pb free.</p>
	<p>●Complies with EU RoHS directive. *About the products without the Pb-free mark. Contains Pb in products exempted by EU RoHS directive (Contains Pb in sealing glass, high melting temperature type solder or other)</p>

NOTICE: PLEASE READ CAREFULLY BELOW BEFORE THE USE OF THIS DOCUMENT ©Seiko Epson Corporation 2020

- The content of this document is subject to change without notice. Before purchasing or using Epson products, please contact with sales representative of Seiko Epson Corporation ("Epson") for the latest information and be always sure to check the latest information published on Epson's official web sites and resources.
- This document may not be copied, reproduced, or used for any other purposes, in whole or in part, without Epson's prior consent.
- Information provided in this document including, but not limited to application circuits, programs and usage, is for reference purpose only. Epson makes no guarantees against any infringements or damages to any third parties' intellectual property rights or any other rights resulting from the information. This document does not grant you any licenses, any intellectual property rights or any other rights with respect to Epson products owned by Epson or any third parties.
- Using Epson products, you shall be responsible for safe design in your products; that is, your hardware, software, and/or systems shall be designed enough to prevent any critical harm or damages to life, health or property, even if any malfunction or failure might be caused by Epson products. In designing your products with Epson products, please be sure to check and comply with the latest information regarding Epson products (including, but not limited to this document, specifications, data sheets, manuals, and Epson's web site). Using technical contents such as product data, graphic and chart, and technical information, including programs, algorithms and application circuit examples under this document, you shall evaluate your products thoroughly both in stand-alone basis and within your overall systems. You shall be solely responsible for deciding whether to adopt/use Epson products with your products.
- Epson has prepared this document carefully to be accurate and dependable, but Epson does not guarantee that the information is always accurate and complete. Epson assumes no responsibility for any damages you incurred due to any misinformation in this document.
- No dismantling, analysis, reverse engineering, modification, alteration, adaptation, reproduction, etc., of Epson products is allowed.
- Epson products have been designed, developed and manufactured to be used in general electronic applications and specifically requires particular quality or extremely high reliability in order to refrain from causing any malfunction or failure leading to critical harm to life and health, serious property damage, or severe impact on society, including, but not limited to listed below ("Specific Purpose"). Therefore, you are strongly advised to use Epson products only for the Anticipated Purpose. Should you desire to purchase and use Epson products for Specific Purpose, Epson makes no warranty and disclaims with respect to Epson products, whether express or implied, including without limitation any implied warranty of merchantability or fitness for any Specific Purpose. Please be sure to contact our sales representative in advance, if you desire Epson products for Specific Purpose:  
Space equipment (artificial satellites, rockets, etc.)/ Transportation vehicles and their control equipment (automobiles, aircraft, trains, ships, etc.) / Medical equipment/ Relay equipment to be placed on sea floor/ Power station control equipment / Disaster or crime prevention equipment/Traffic control equipment/ Financial equipment  
Other applications requiring similar levels of reliability as the above
- Epson products listed in this document and our associated technologies shall not be used in any equipment or systems that laws and regulations in Japan or any other countries prohibit to manufacture, use or sell. Furthermore, Epson products and our associated technologies shall not be used for the purposes of military weapons development (e.g. mass destruction weapons), military use, or any other military applications. If exporting Epson products or our associated technologies, please be sure to comply with the Foreign Exchange and Foreign Trade Control Act in Japan, Export Administration Regulations in the U.S.A (EAR) and other export-related laws and regulations in Japan and any other countries and to follow their required procedures.
- Epson assumes no responsibility for any damages (whether direct or indirect) caused by or in relation with your non-compliance with the terms and conditions in this document or for any damages (whether direct or indirect) incurred by any third party that you give, transfer or assign Epson products.
- For more details or other concerns about this document, please contact our sales representative.
- Company names and product names listed in this document are trademarks or registered trademarks of their respective companies.