

Crystal Oscillator (SPXO)

- Package size (7.0 mm × 5.0 mm × 1.5 mm)
- Fundamental mode SPXO
- Output: LVDS
- Reference weight Typ.165 mg

[1] Product Number / Product Name / Marking

(1-1) Product Number / Ordering Code

X1G0053310015xx

Last 2 digits code(**xx**) defines Quantity.

The standard is "00", 1 000 pcs/Reel.

(1-2) Product Name / Model Name

SG7050VEN 125.000000MHz CJGA

[2] Operating Range

Parameter	Symbol	Specifications			Unit	Conditions
		Min.	Typ.	Max.		
Supply voltage	V _{CC}	3.135	3.3	3.465	V	-
	GND	0	-	0	V	-
Operating temperature range	T _{use}	-40	-	85	°C	-
LVDS load condition	L_LVDS	-	100	-	Ω	Connected between OUT and $\bar{O}UT$

[3] Frequency Characteristics

(Unless stated otherwise [2] Operating Range)

Parameter	Symbol	Specifications			Unit	Conditions
		Min.	Typ.	Max.		
Output frequency	f _o	-	125.000000	-	MHz	-
Frequency tolerance *1	f _{tol}	-50	-	+50	×10 ⁻⁶	T _{use}

*1 Frequency tolerance includes Initial frequency tolerance, Frequency / temperature characteristics, Frequency / voltage coefficient, and aging (10 years, +25 °C).

[4] Electrical Characteristics

(Unless stated otherwise [2] Operating Range)

Parameter	Symbol	Specifications			Unit	Conditions
		Min.	Typ.	Max.		
Start-up time	t _{str}	-	-	10	ms	t = 0 at 90 % V _{cc}
Current consumption	I _{CC}	-	-	25	mA	OE = V _{cc} , L_LVDS = 100 Ω
Disable current	I _{dis}	-	-	15	mA	OE = GND
Output voltage	V _{OD}	250	350	450	mV	V _{OD1} , V _{OD2}
	dV _{OD}	-	-	50	mV	V _{OD1} - V _{OD2}
	V _{OS}	1.15	1.25	1.35	V	V _{OS1} , V _{OS2}
	dV _{OS}	-	-	50	mV	V _{OS1} - V _{OS2}
Rise time	t _r	-	-	0.3	ns	At 20 % to 80 % output swing
Fall time	t _f	-	-	0.3	ns	At 80 % to 20 % output swing
Symmetry	SYM	45	50	55	%	At output crossing point
Input voltage	V _{IH}	70 % V _{cc}	-	-	V	OE Terminal
	V _{IL}	-	-	30 % V _{cc}	V	OE Terminal
Output disable time (OE)	t _{stp_oe}	-	-	100	ns	OE terminal HIGH → LOW
Output enable time (OE)	t _{sta_oe}	-	-	500	ns	OE terminal LOW → HIGH

[For other general specifications, please refer to the attached Full Data Sheet below]

Low Phase Jitter Crystal Oscillator: SG3225 / 5032 / 7050VEN

Features

- Crystal oscillator (SPXO)
- Frequency range (fo): 25 MHz to 500 MHz
- Output: LVDS
- Supply voltage: 2.5 V Typ. / 3.3 V Typ.
- Operating temperature: -40 °C to +105 °C
- Low phase jitter: 60 fs Typ. (fo = 156.25 MHz)

Applications

- Network equipment (Router, Switch, Optical module, etc.)
- Data center
- Test and Measurement Equipment, Factory Automation
- High Speed Converters like ADC and DAC

Description

5G will increase the communication traffic exponentially. A 5G communication network requires high-speed and wide-band, while keeping the noise level to a minimum. This can be achieved with a high frequency low jitter reference clock for the communication equipment. Using the above XO, customers can input a high frequency reference (up to 500 MHz) with extremely low phase jitter and power, from a fundamental mode crystal to achieve excellent phase noise.

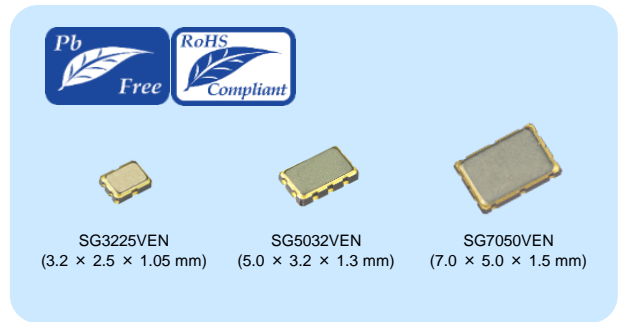

Outline Drawing and Terminal Assignment

SG7050VEN



SG5032VEN

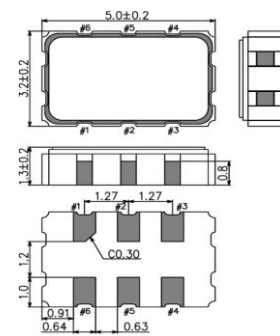

SG3225VEN



Pin	Connection
1	OE
2	N.C. (Open or V _{CC})
3	GND
4	OUT
5	OUT
6	V _{CC}

Typical Performance

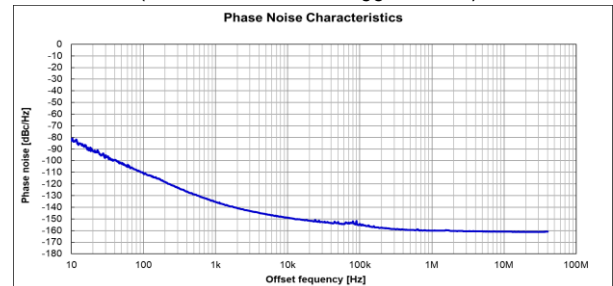
Phase Noise (fo = 156.25 MHz, V_{CC} = 3.3 V)

Phase Jitter (12 kHz to 20 MHz): 60 fs Typ.

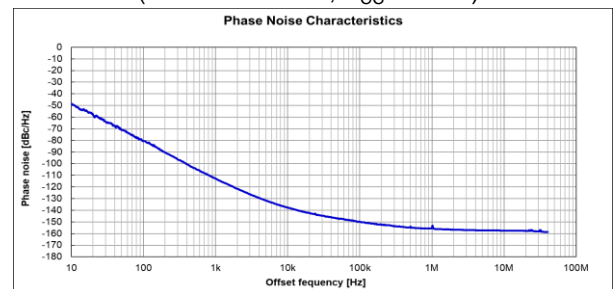
Phase Noise (fo = 491.52 MHz, V_{CC} = 3.3 V)

Phase Jitter (12 kHz to 20 MHz): 30 fs Typ.

[1] Product Number / Product Name

(1-1) Product Number

SG3225VEN: X1G005351xxxx00 (fo ≤ 200 MHz)
 X1G005521xxxx00 (fo > 200 MHz)
 SG5032VEN: X1G005541xxxx00 (fo > 200 MHz)
 SG7050VEN: X1G005331xxxx00 (fo ≤ 200 MHz)
 X1G005561xxxx00 (fo > 200 MHz)

(Please contact Epson for details)

(1-2) Product Name (Standard Form)

SG3225 V EN 156.250000MHz C D G A (⑤⑥: Unavailable code DH and DG, JH at fo > 200 MHz)

① ② ③ ④ ⑤ ⑥ ⑦

- ① Model
- ② Output (V: LVDS)
- ③ Frequency
- ④ Supply voltage
- ⑤ Frequency tolerance
- ⑥ Operating temperature
- ⑦ Internal identification code ("A" is default)

④ Supply voltage	
D	2.5 V Typ.
C	3.3 V Typ.

⑤ Frequency tolerance	
D	±25 × 10 ⁻⁶
J	±50 × 10 ⁻⁶
L	±100 × 10 ⁻⁶

⑥ Operating temperature	
G	-40 °C to +85 °C
H	-40 °C to +105 °C

Available code for ⑥ Operating temperature

⑤ f_{tol} [x 10⁻⁶]

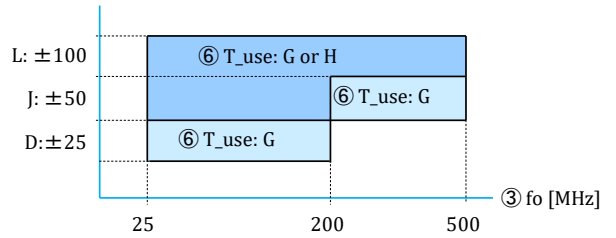

Please note that the available code for ⑥ Operating temperature (T_{use}) depends on ③ Frequency (fo) and ⑤ Frequency tolerance (f_{tol}).

[2] Absolute Maximum Ratings

Parameter	Symbol	Specification			Unit	Conditions
		Min.	Typ.	Max.		
Maximum supply voltage	V _{CC}	-0.5	-	4	V	fo ≤ 200 MHz
		-0.5	-	5	V	fo > 200 MHz
Input voltage	V _{in}	-0.5	-	V _{CC} + 0.5	V	OE terminal
Storage temperature range	T _{stg}	-55	-	125	°C	

[3] Operating Range

Parameter	Symbol	Specification			Unit	Conditions
		Min.	Typ.	Max.		
Supply voltage	V _{CC}	2.375	2.5	2.625	V	Suffix: D
		3.135	3.3	3.465	V	Suffix: C
Supply voltage	GND	0.0	0.0	0.0	V	
Operating temperature range	T _{use}	-40	+25	+85	°C	Suffix: G
		-40	+25	+105	°C	Suffix: H
LVDS load condition	L _{LVDS}	100			Ω	Connected between OUT and $\bar{O}UT$

* Power supply startup time (0 %V_{CC}→90 %V_{CC}) should be more than 150 μs

* A 0.1 μF and a 10 μF bypass capacitor should be connected between V_{CC} and GND pins located close to the device

[4] Frequency Characteristics

(Unless stated otherwise [3] Operating Range)

Parameter	Symbol	Specification			Unit	Conditions
		Min.	Typ.	Max.		
Output frequency *1	fo	25	-	500	MHz	SG3225VEN / SG7050VEN
		200.000001	-	500	MHz	SG5032VEN
Frequency tolerance	f_tol	-25	-	+25	$\times 10^{-6}$	*2 Suffix: D fo ≤ 200 MHz, T_use: G
		-50	-	+50	$\times 10^{-6}$	*3 Suffix: J T_use: G
		-100	-	+100	$\times 10^{-6}$	*3 Suffix: J fo ≤ 200 MHz, T_use: H
		-100	-	+100	$\times 10^{-6}$	*3 Suffix: L T_use: H

*1 Please contact Epson for available frequencies

*2 Frequency tolerance includes Initial frequency tolerance, Frequency / temperature characteristics, Frequency / voltage coefficient and aging (5 years, +25 °C).

*3 Frequency tolerance includes Initial frequency tolerance, Frequency / temperature characteristics, Frequency / voltage coefficient and aging (10 years, +25 °C).

[5] Electrical Characteristics

(Unless stated otherwise [3] Operating Range)

Parameter	Symbol	Specification			Unit	Conditions
		Min.	Typ.	Max.		
Startup time	t_str	-	-	10	ms	t = 0 at 90 %V _{CC}
Current consumption	I _{CC}	-	-	25	mA	
Disable current	I _{dis}	-	-	15	mA	OE = GND
Rise time / Fall time	tr / tf	-	-	0.3	ns	20 % - 80 % of differential output peak to peak voltage
Symmetry	SYM	45	50	55	%	At output crossing point
Output voltage	V _{OD}	250	350	450	mV	DC characteristics
	dV _{OD}	-	-	50	mV	
	V _{OS}	1.15	1.25	1.35	V	
	dV _{OS}	-	-	50	mV	
Input voltage	V _{IH}	70 % V _{CC}	-	-	V	OE terminal
	V _{IL}	-	-	30 % V _{CC}	V	
Output disable time	tstp_oe	-	-	100	ns	OE terminal HIGH → LOW
Output enable time	tsta_oe	-	-	200	ns	fo ≤ 200 MHz, OE terminal LOW → HIGH
		-	-	500	ns	fo > 200 MHz, OE terminal LOW → HIGH
Phase jitter (fo = 25 MHz)	t _{PJ}	-	164.8	-	fs	Offset frequency 12 kHz to 5 MHz
Phase jitter (fo = 50 MHz)	t _{PJ}	-	183.1	-	fs	
Phase jitter (fo = 100 MHz)	t _{PJ}	-	96.1	150	fs	
Phase jitter (fo = 125 MHz)	t _{PJ}	-	71.1	110	fs	
Phase jitter (fo = 156.25 MHz)	t _{PJ}	-	59.6	90	fs	
Phase jitter (fo = 212.5 MHz)	t _{PJ}	-	36.2	80	fs	
Phase jitter (fo = 312.5 MHz)	t _{PJ}	-	37.0	80	fs	
Phase jitter (fo = 491.52 MHz)	t _{PJ}	-	29.2	60	fs	
Phase jitter (fo = 491.52 MHz)	t _{PJ}	-	29.2	60	fs	

[6] Thermal resistance (For reference only)

Parameter	Symbol	Specification			Unit	Conditions
		Min.	Typ.	Max.		
Junction temperature	T_j	-	-	140	°C	
Junction to case	θ_{jc}	-	97.9	-	°C/W	SG3225VEN
		-	102.6	-	°C/W	SG5032VEN
		-	42.6	-	°C/W	SG7050VEN
Junction to ambient	θ_{ja}	-	155.4	-	°C/W	SG3225VEN
		-	150.1	-	°C/W	SG5032VEN
		-	75.2	-	°C/W	SG7050VEN

[7] Typical Performance Characteristics (For reference only)

The following data shows typical performance characteristics

(7-1) Frequency / Temperature Characteristics

$f_o = 100 \text{ MHz}$

$n = 50 \text{ pcs}$

-40 °C to +85 °C (Suffix: G), reference at +25 °C

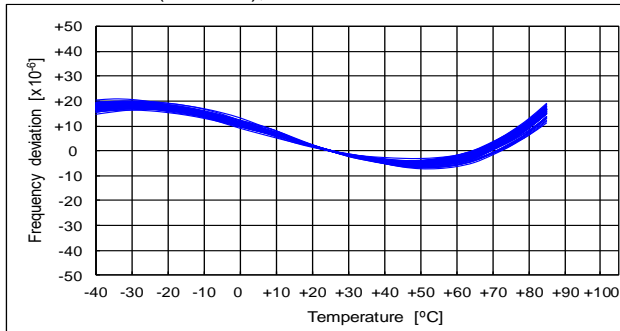

-40 °C to +105 °C (Suffix: H), reference at +25 °C

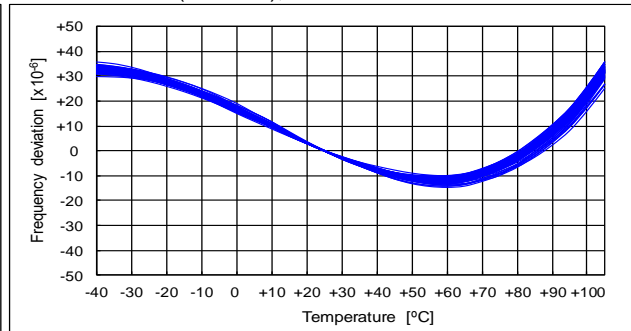

$f_o = 125 \text{ MHz}$

$n = 50 \text{ pcs}$

-40 °C to +85 °C (Suffix: G), reference at +25 °C

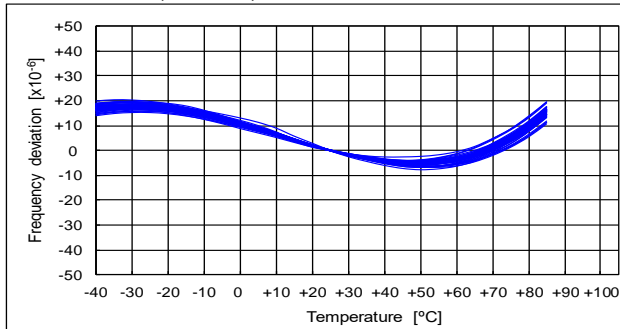

-40 °C to +105 °C (Suffix: H), reference at +25 °C

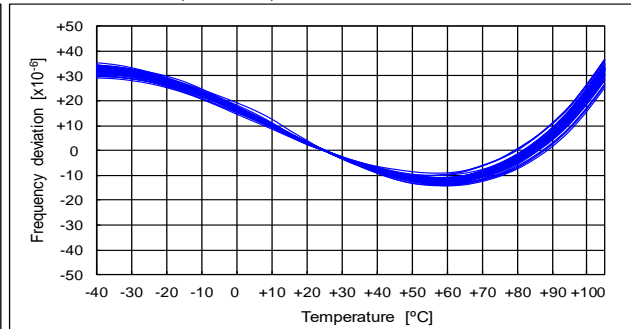

$f_o = 156.25 \text{ MHz}$

$n = 50 \text{ pcs}$

-40 °C to +85 °C (Suffix: G), reference at +25 °C

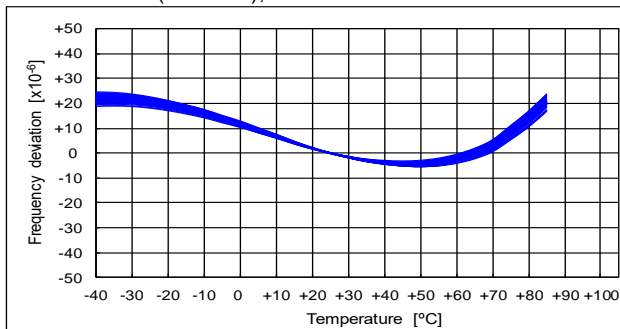

-40 °C to +105 °C (Suffix: H), reference at +25 °C

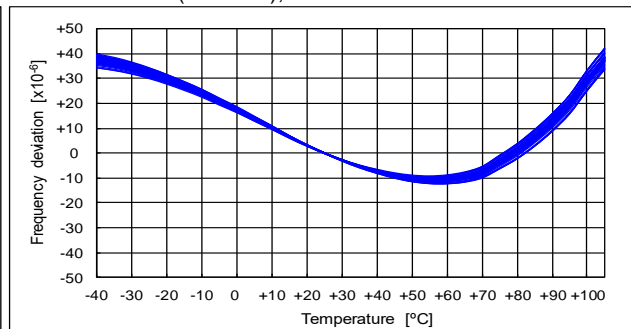

(7-1) Frequency / Temperature Characteristics [cont'd]

fo = 212.5 MHz

n = 50 pcs

-40 °C to +85 °C (Suffix: G), reference at +25 °C



-40 °C to +105 °C (Suffix: H), reference at +25 °C

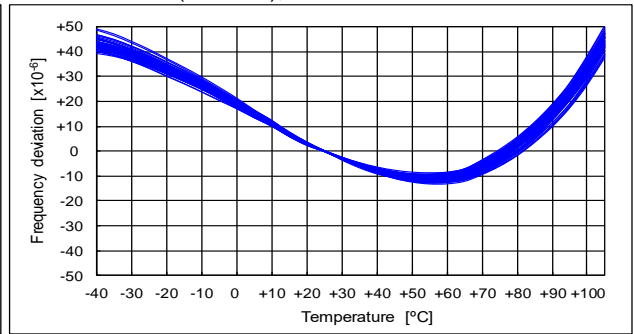

fo = 312.5 MHz

n = 50 pcs

-40 °C to +85 °C (Suffix: G), reference at +25 °C

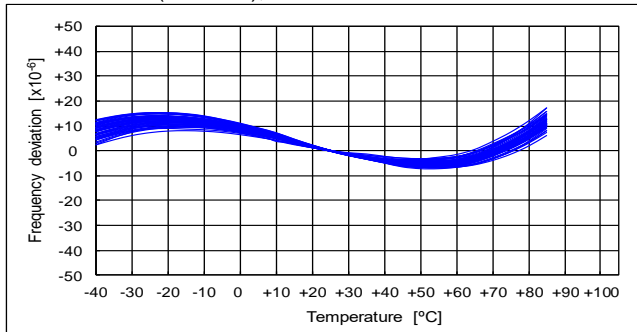

-40 °C to +105 °C (Suffix: H), reference at +25 °C

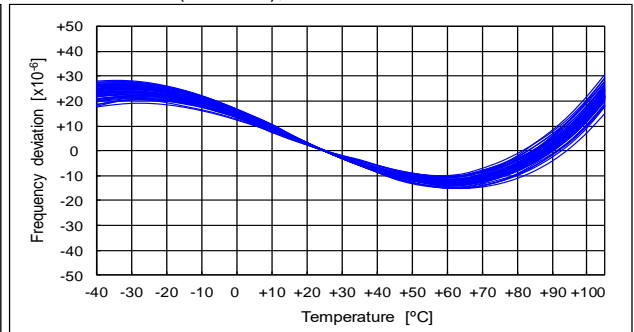

fo = 491.52 MHz

n = 50 pcs

-40 °C to +85 °C (Suffix: G), reference at +25 °C



-40 °C to +105 °C (Suffix: H), reference at +25 °C

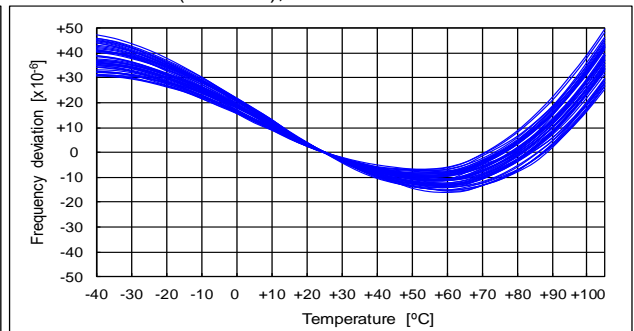

(7-2) Current Consumption

$T_{use} = +25\text{ }^{\circ}\text{C}$, Frequency Dependency

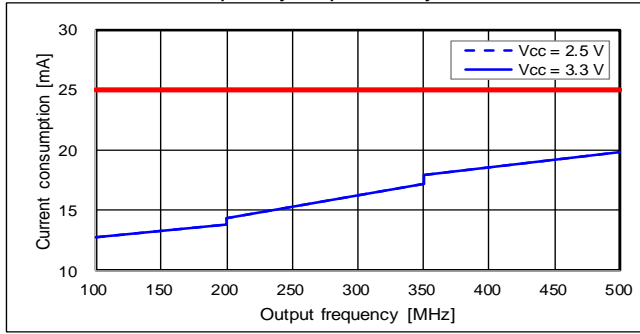

$V_{CC} = 2.5\text{ V}$, Temperature Characteristic

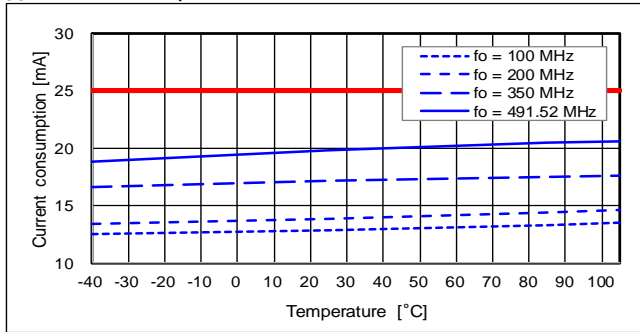

$V_{CC} = 3.3\text{ V}$, Temperature Characteristic

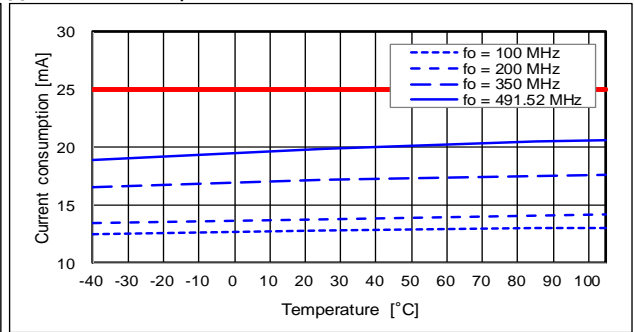

(7-3) Rise Time / Fall Time Temperature Characteristic

fo = 100 MHz

Rise Time

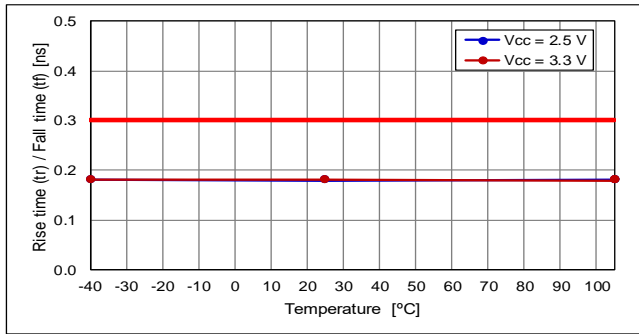

Fall Time

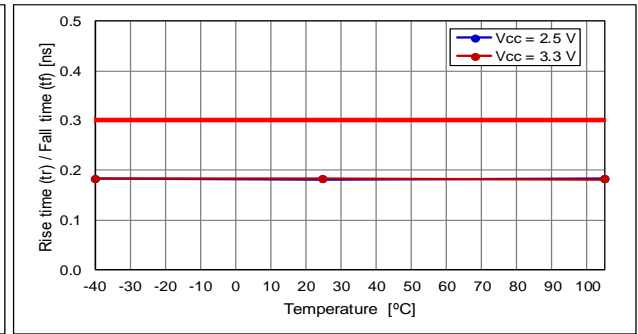

fo = 200 MHz

Rise Time

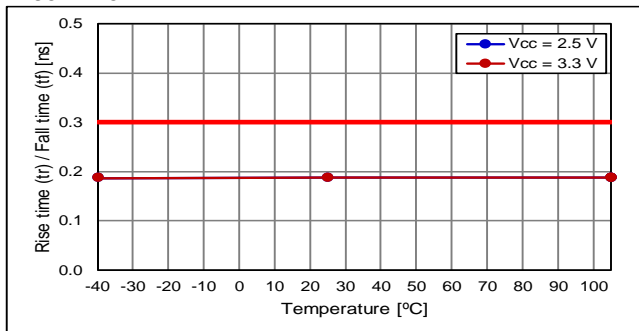

Fall Time

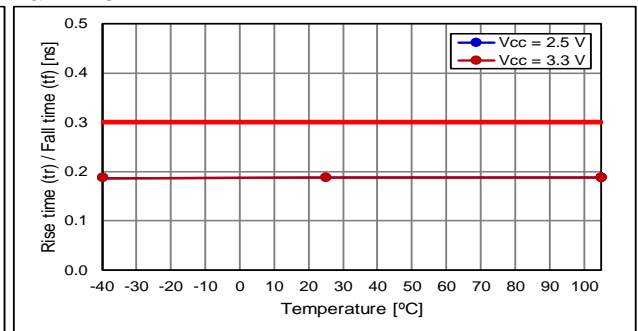

fo = 350 MHz

Rise Time

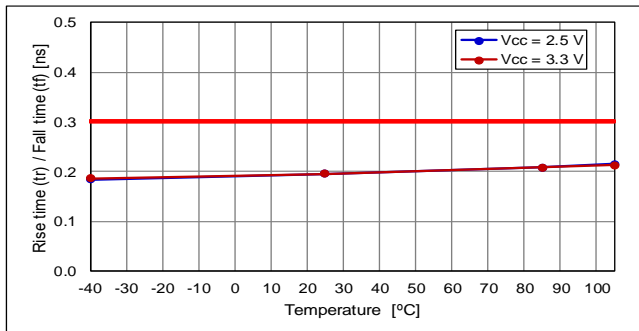

Fall Time

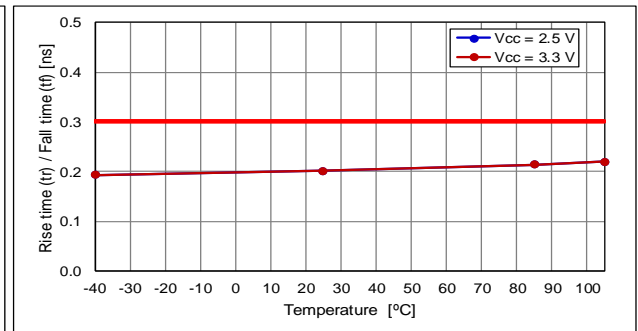

fo = 491.52 MHz

Rise Time

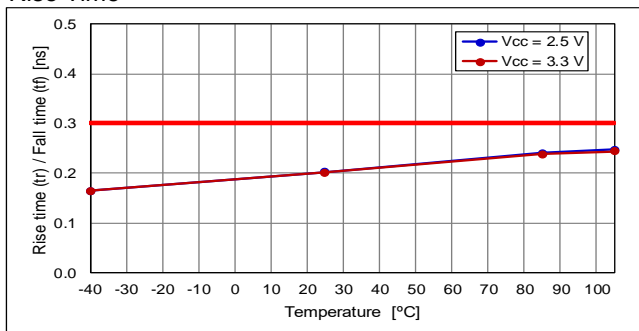

Fall Time

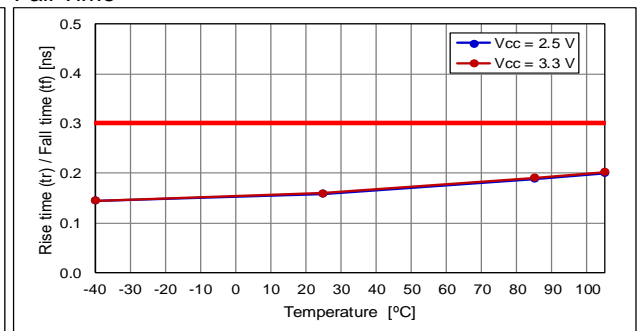

(7-4) Symmetry Temperature Characteristic

fo = 100 MHz

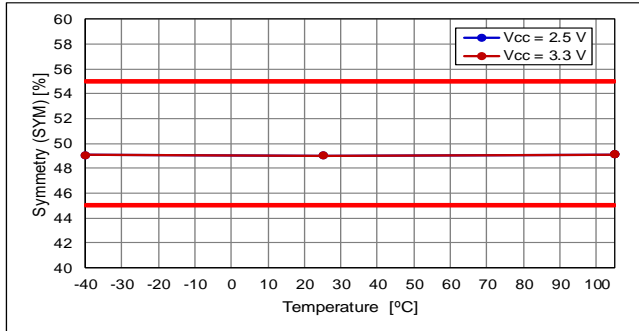

fo = 200 MHz

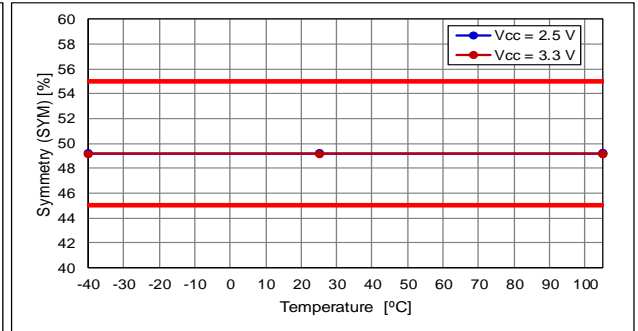

fo = 350 MHz

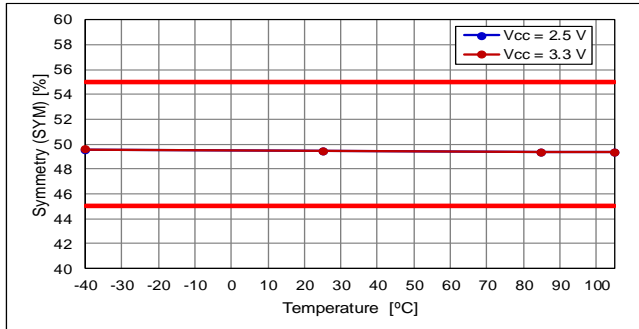

fo = 491.52 MHz

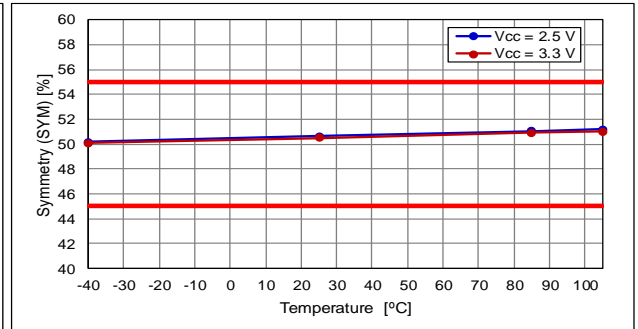

(7-5) Output Voltage Temperature Characteristic

V_{OD}

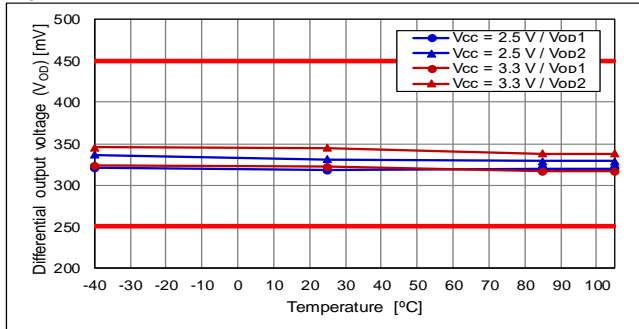

dV_{OD}

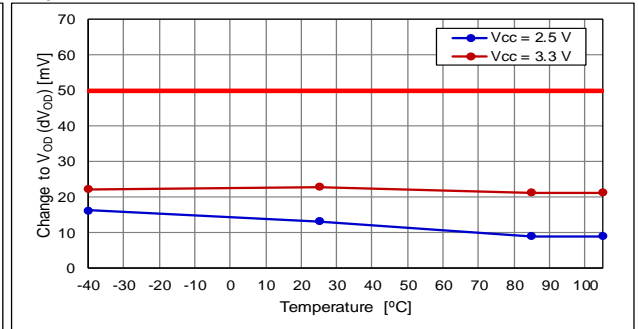

V_{OS}

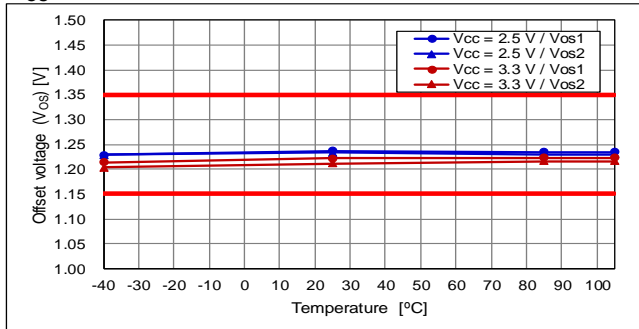

dV_{OS}

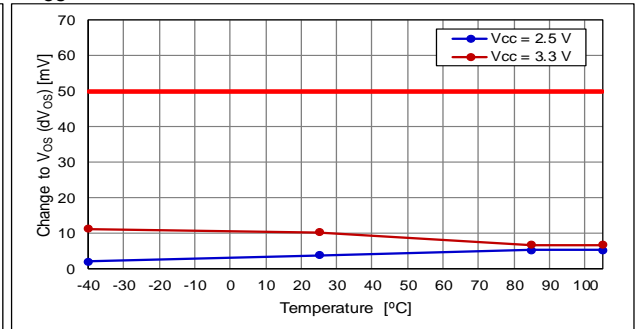

(7-6) Phase Noise and Phase Jitter

fo = 25 MHz, T_use = +25 °C

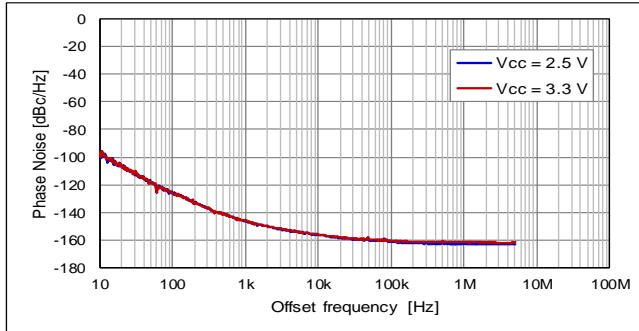

V _{CC}	Phase Jitter*
2.5 V	145 fs
3.3 V	165 fs

* Offset frequency: 12 kHz to 5 MHz

fo = 50 MHz, T_use = +25 °C

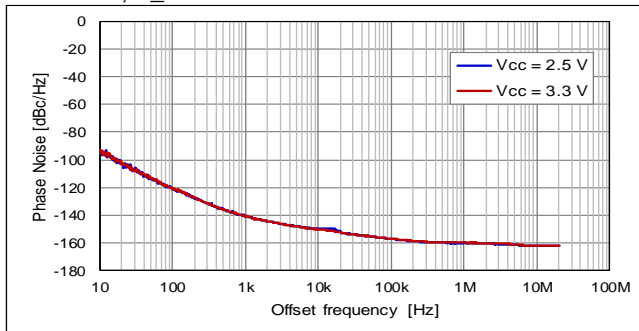

V _{CC}	Phase Jitter*
2.5 V	177 fs
3.3 V	183 fs

* Offset frequency: 12 kHz to 20 MHz

fo = 100 MHz, T_use = +25 °C

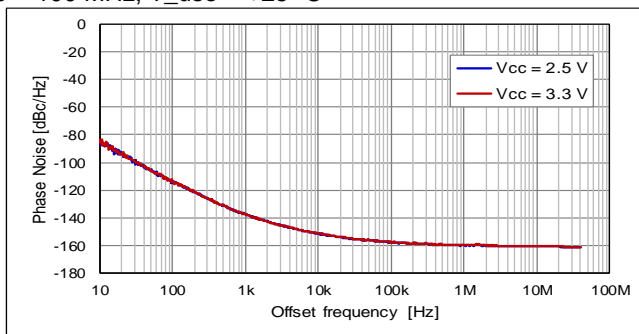

V _{CC}	Phase Jitter*
2.5 V	95 fs
3.3 V	96 fs

* Offset frequency: 12 kHz to 20 MHz

fo = 125 MHz, T_use = +25 °C

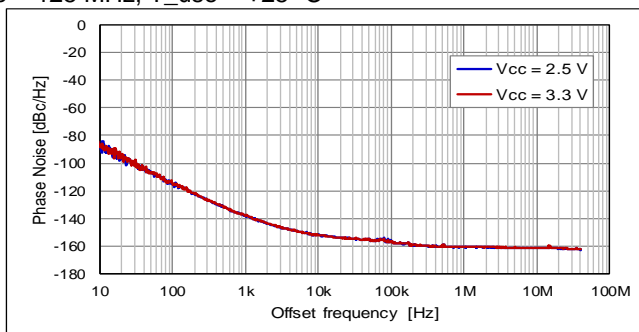

V _{CC}	Phase Jitter*
2.5 V	70 fs
3.3 V	71 fs

* Offset frequency: 12 kHz to 20 MHz

(7-6) Phase Noise and Phase Jitter [cont'd]

fo = 156.25 MHz, T_use = +25 °C

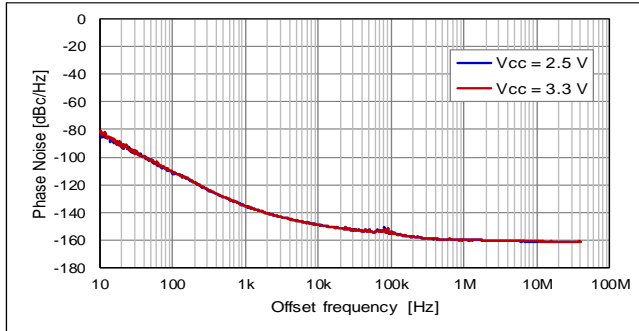

V _{CC}	Phase Jitter*
2.5 V	59 fs
3.3 V	60 fs

* Offset frequency: 12 kHz to 20 MHz

fo = 212.5 MHz, T_use = +25 °C

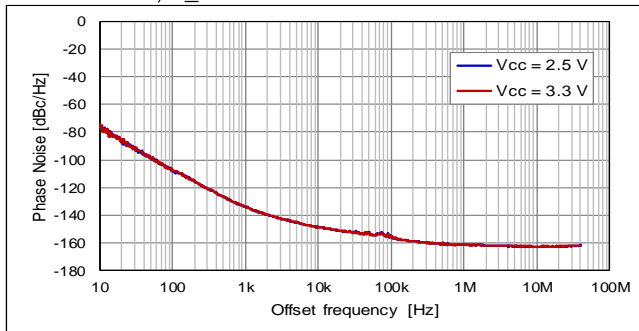

V _{CC}	Phase Jitter*
2.5 V	36 fs
3.3 V	36 fs

* Offset frequency: 12 kHz to 20 MHz

fo = 312.5 MHz, T_use = +25 °C

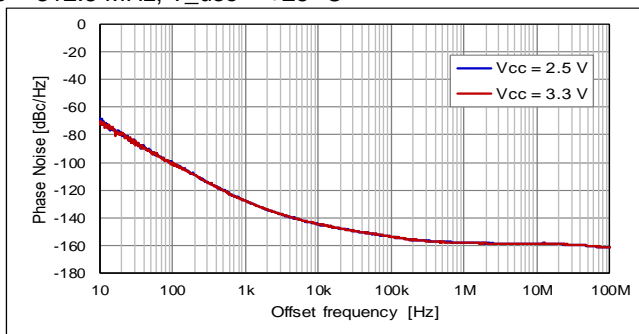

V _{CC}	Phase Jitter*
2.5 V	37 fs
3.3 V	37 fs

* Offset frequency: 12 kHz to 20 MHz

fo = 491.52 MHz, T_use = +25 °C

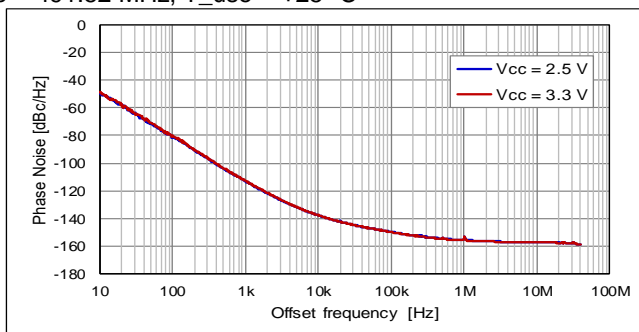

V _{CC}	Phase Jitter*
2.5 V	29 fs
3.3 V	29 fs

* Offset frequency: 12 kHz to 20 MHz

[8] Test Circuit

(8-1) Output Frequency and Current Consumption Test Setup

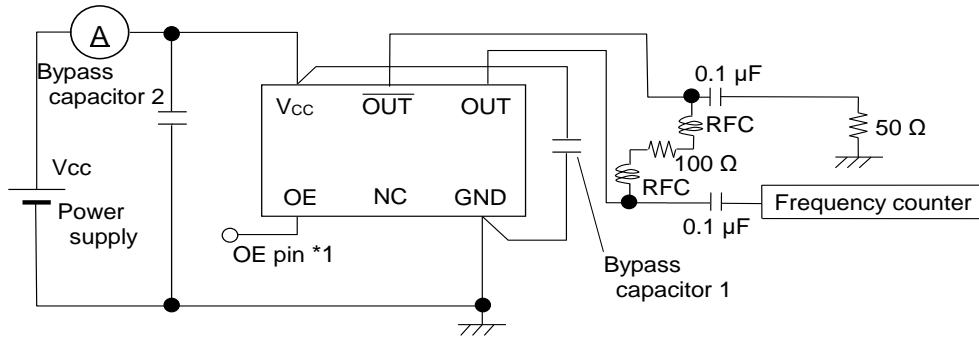

(8-2) Waveform Observation Test Setup

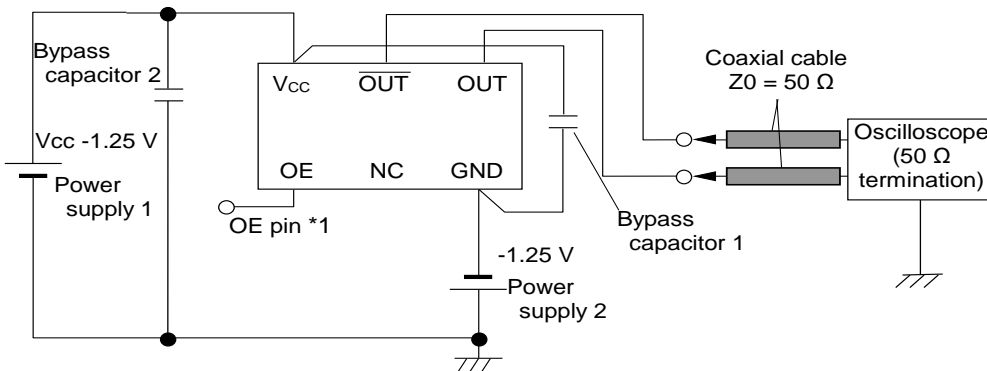

* Each output trace should be same length

* To measure Disable Current, OE terminal is connected to GND

(8-3) Conditions

(1) Oscilloscope

The bandwidth should be a minimum of 5 times wider than the measurement frequency

(2) A 0.1 μF and a 10 μF bypass capacitor should be connected between V_{CC} and GND pins located close to the device

(3) Use a current meter with a low internal impedance

(4) Power Supply

Power supply startup time ($0\%V_{CC} \rightarrow 90\%V_{CC}$) should be more than 150 μs

Power supply impedance should be as low as possible

(8-4) Timing Chart

(1) Output Waveform and Level

Differential Output Voltage

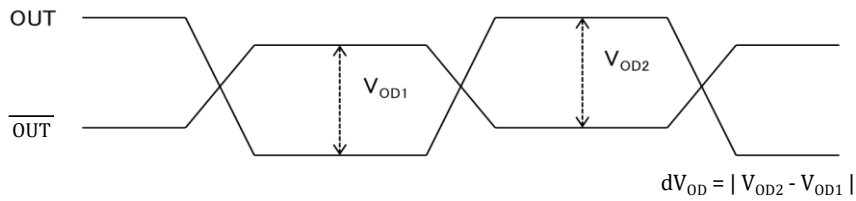

Offset Voltage

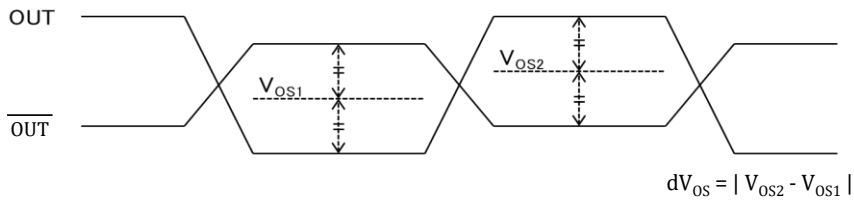

Symmetry

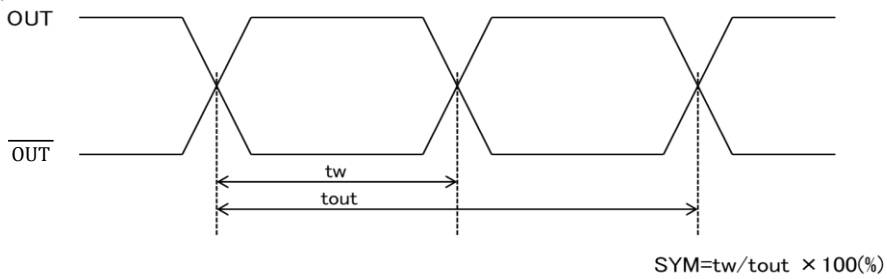

Rise Time / Fall Time

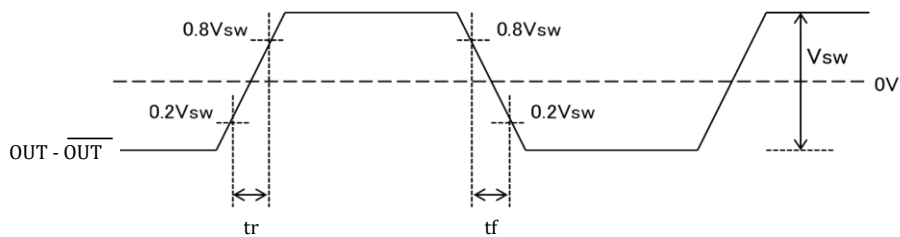

(2) Output Frequency Timing

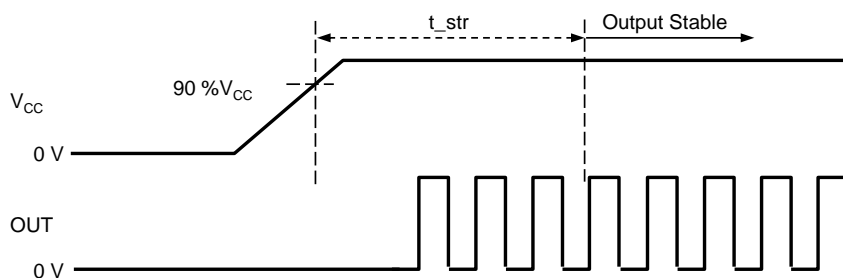

(8-4) Timing Chart [cont'd]

(3) OE Function and Timing

OE Terminal	Osc. Circuit	Output status
"H" or OPEN	Oscillation	Specified frequency is output: Enable
"L"	Oscillation	Output becomes high impedance: Disable

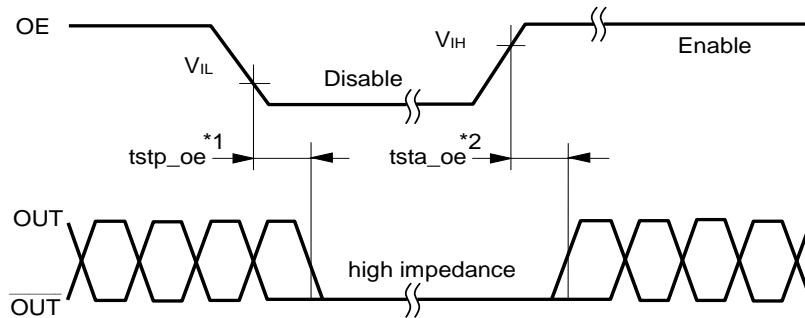

*1 The period from OE = V_{IL} to OUT = High impedance (Disable)

*2 The period from OE = V_{IH} to OUT = Enable

* OE terminal voltage level should not exceed supply voltage when using OE function.

Please note that OE rise time should not exceed supply voltage rise time at the start-up.

[9] Outline Drawing and Recommended Footprint
(9-1) SG3225VEN

Units: mm

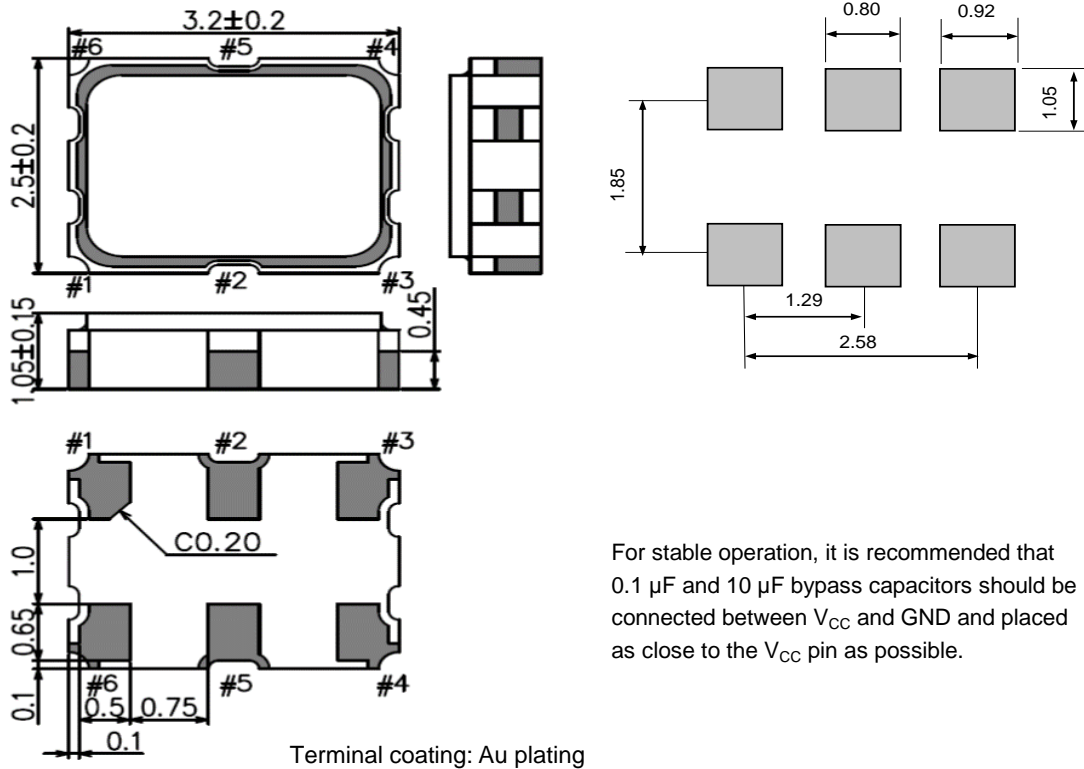

For stable operation, it is recommended that 0.1 μ F and 10 μ F bypass capacitors should be connected between V_{CC} and GND and placed as close to the V_{CC} pin as possible.

Reference Weight Typ.: 26 mg

Terminal Assignment

Pin #	Connection	Function		
#1	OE	OE terminal / active high		
		OE function	Osc. circuit	Output
		"H" or OPEN	Oscillation	Specified frequency: Enable
		"L"	Oscillation	High impedance: Disable
#2	NC	—		
#3	GND	GND terminal		
#4	OUT	Output terminal (Positive)		
#5	$\bar{O}U\bar{T}$	Output terminal (Negative)		
#6	V_{CC}	V_{CC} terminal		

Marking

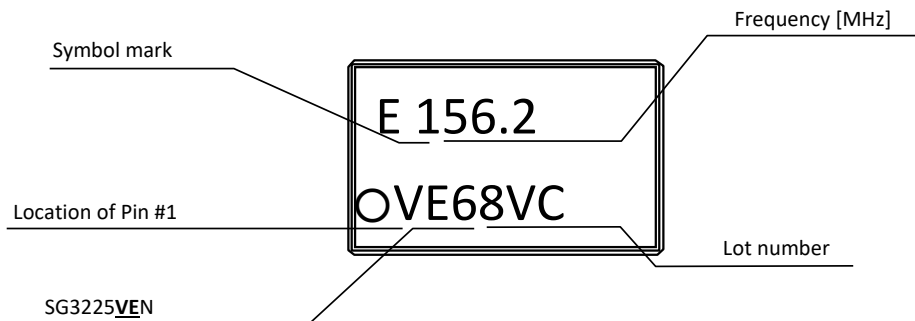

(9-2) SG5032VEN

Units: mm

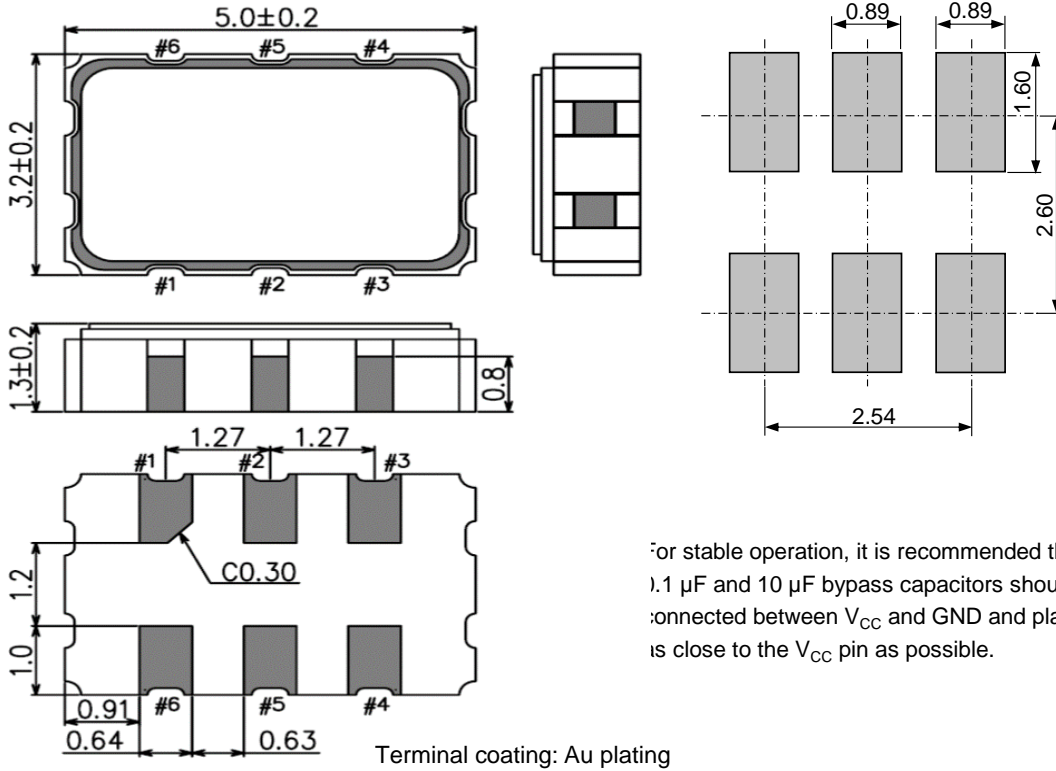

For stable operation, it is recommended that 0.1 μF and 10 μF bypass capacitors should be connected between V_{CC} and GND and placed as close to the V_{CC} pin as possible.

Reference Weight Typ.: 65 mg

Terminal Assignment

Pin #	Connection	Function		
#1	OE	OE terminal / active high		
		OE function	Osc. circuit	Output
		"H" or OPEN	Oscillation	Specified frequency: Enable
		"L"	Oscillation	High impedance: Disable
#2	NC	—		
#3	GND	GND terminal		
#4	OUT	Output terminal (Positive)		
#5	$\bar{O}UT$	Output terminal (Negative)		
#6	V _{CC}	V _{CC} terminal		

Marking

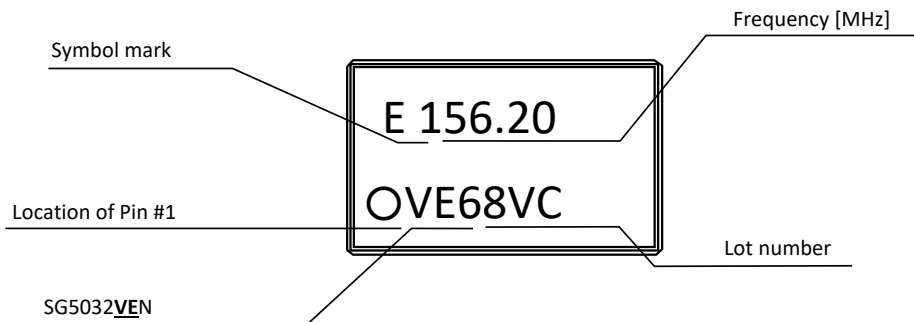

(9-3) SG7050VEN

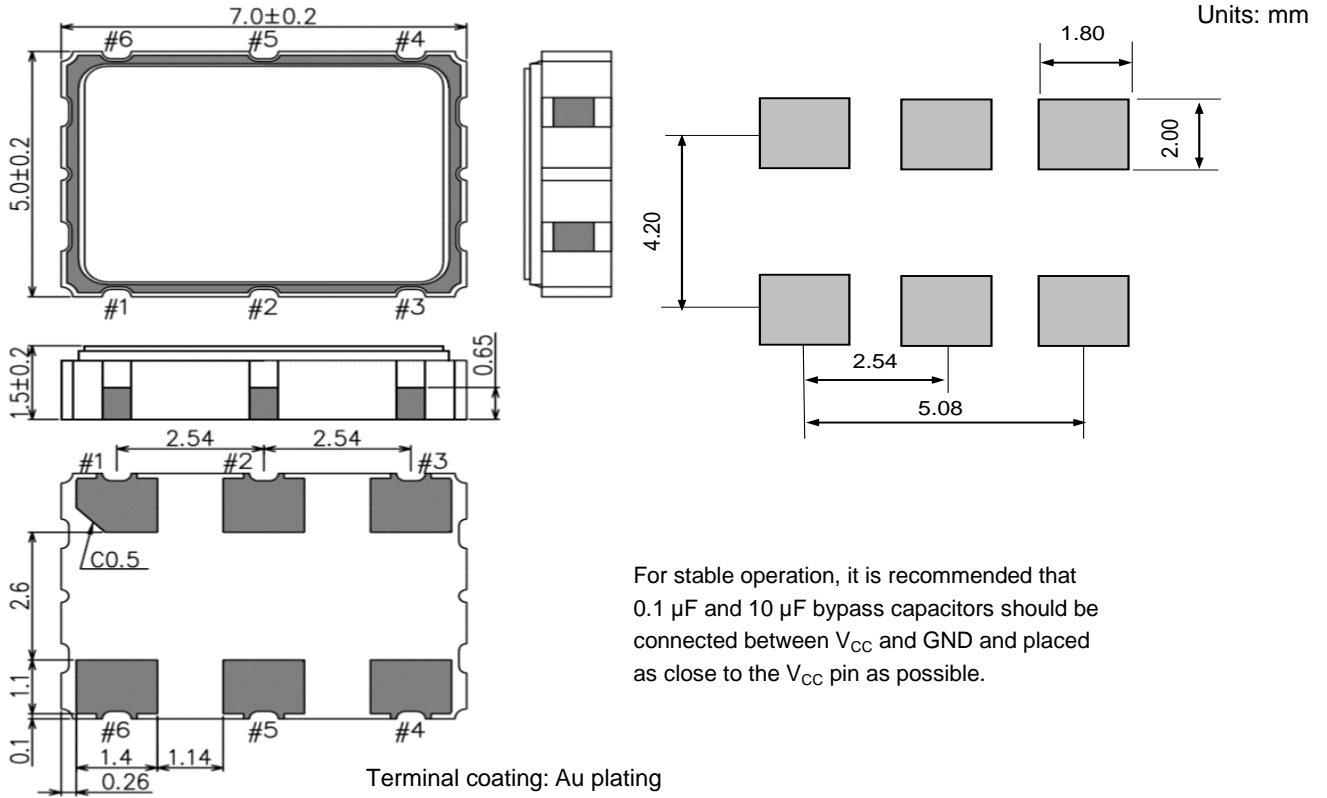

Reference Weight Typ.: 165 mg

Terminal Assignment

Pin #	Connection	Function		
#1	OE	OE terminal / active high		
		OE function	Osc. circuit	Output
		"H" or OPEN	Oscillation	Specified frequency: Enable
		"L"	Oscillation	High impedance: Disable
#2	NC	—		
#3	GND	GND terminal		
#4	OUT	Output terminal (Positive)		
#5	\overline{OUT}	Output terminal (Negative)		
#6	V_{CC}	V_{CC} terminal		

Marking

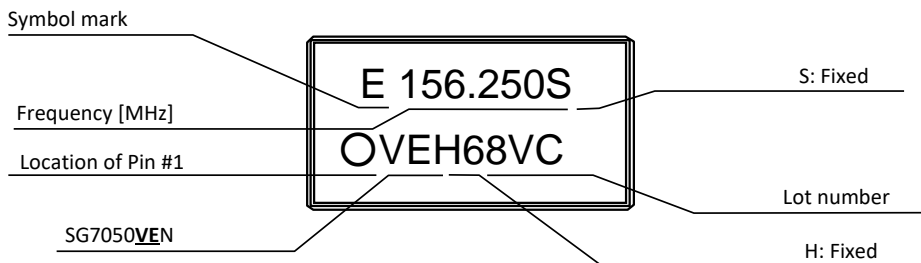

[10] Moisture Sensitivity Level

Parameter	Specification	Conditions
MSL	LEVEL 1	IPC/JEDEC J-STD-020D.1

[11] Reflow Profile

IPC/JEDEC J-STD-020D.1

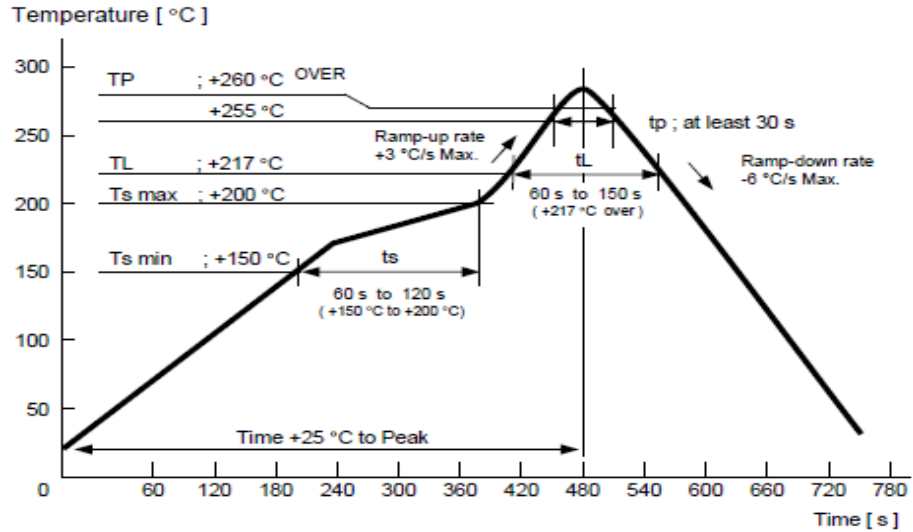

[12] Packing Information

(12-1) SG3225VEN

(1) Packing Quantity

The last two digits of the Product Number (X1G005351xxxxxx / X1G005521xxxxxx) are a code that defines the packing quantity. The standard is "00" for a 2 000 pcs/Reel.

(2) Taping Specification

Subject to EIA-481, IEC-60286 and JIS C0806

1) Tape Dimensions

Carrier Tape Material: PS (Polystyrene)

Top Tape Material: PET (Polyethylene Terephthalate) + PE (Polyethylene)

Units: mm

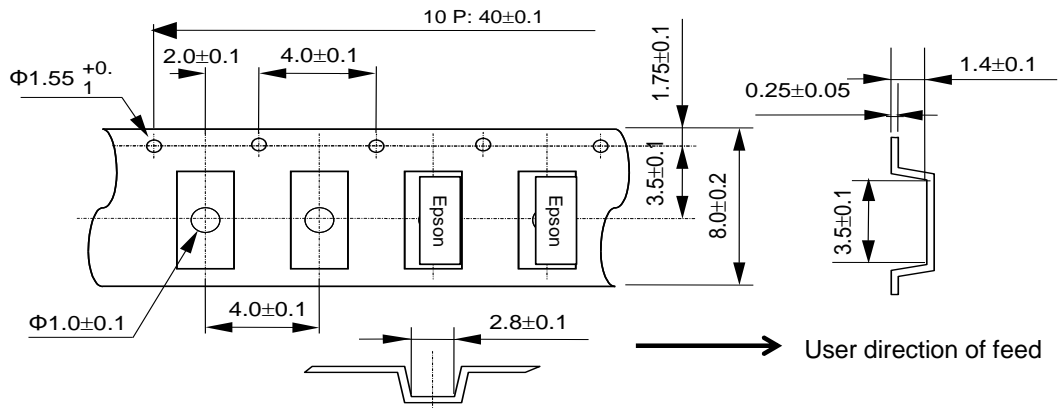

2) Reel Dimensions

Center Material: PS (Polystyrene)

Reel Material: PS (Polystyrene)

Units: mm

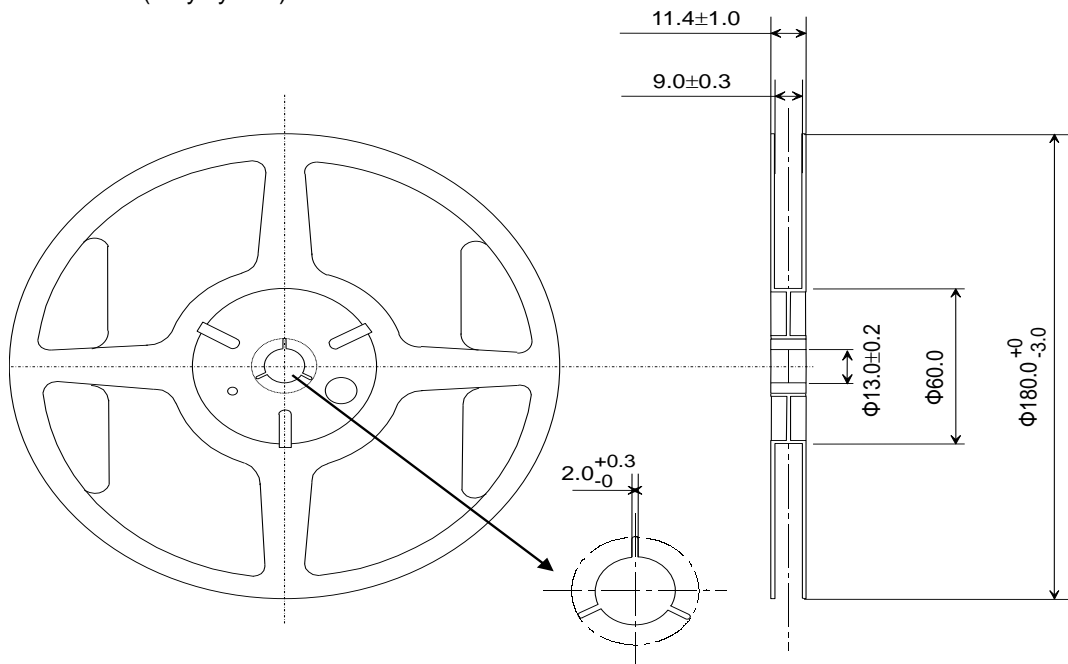

3) Storage Environment

We recommend to keep at normal temperature and normal humidity in a packed condition.

(12-2) SG5032VEN

(1) Packing Quantity

The last two digits of the Product Number (X1G005541xxxxxx) are a code that defines the packing quantity. The standard is "00" for a 1 000 pcs/Reel.

(2) Taping Specification

Subject to EIA-481, IEC-60286 and JIS C0806

1) Tape Dimensions

Carrier Tape Material: PS (Polystyrene)

Top Tape Material: PET (Polyethylene Terephthalate)

Units: mm

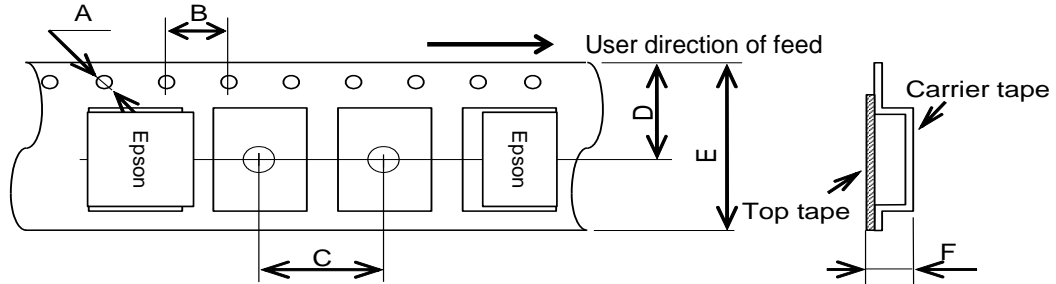

Symbol	A	B	C	D	E	F	G	H
Dimension	Φ1.5	4.0	8.0	7.25	12.0	1.7	3.5	5.4

2) Reel Dimensions

Center Material: PS (Polystyrene)

Reel Material: PS (Polystyrene)

Units: mm

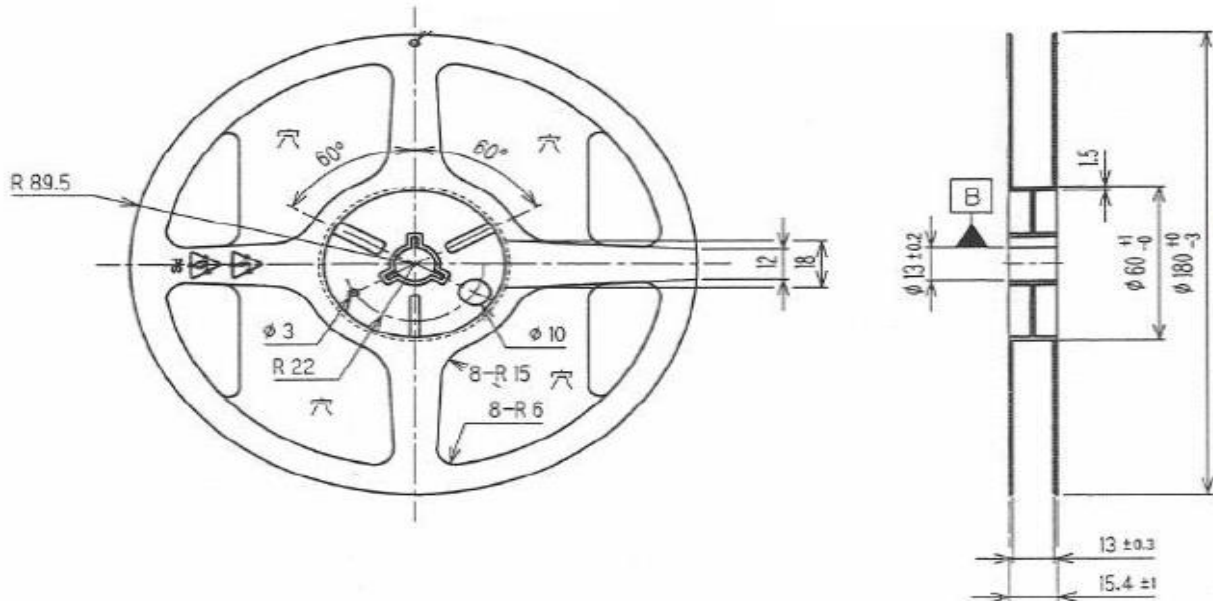

3) Storage Environment

We recommend to keep at normal temperature and normal humidity in a packed condition.

(12-3) SG7050VEN

(1) Packing Quantity

The last two digits of the Product Number (X1G005331xxxxxx / X1G005561xxxxxx) are a code that defines the packing quantity. The standard is "00" for a 1 000 pcs/Reel.

(2) Taping Specification

Subject to EIA-481, IEC-60286 and JIS C0806

1) Tape Dimensions

Carrier Tape Material: PS (Polystyrene)

Top Tape Material: PET (Polyethylene Terephthalate)

Units: mm

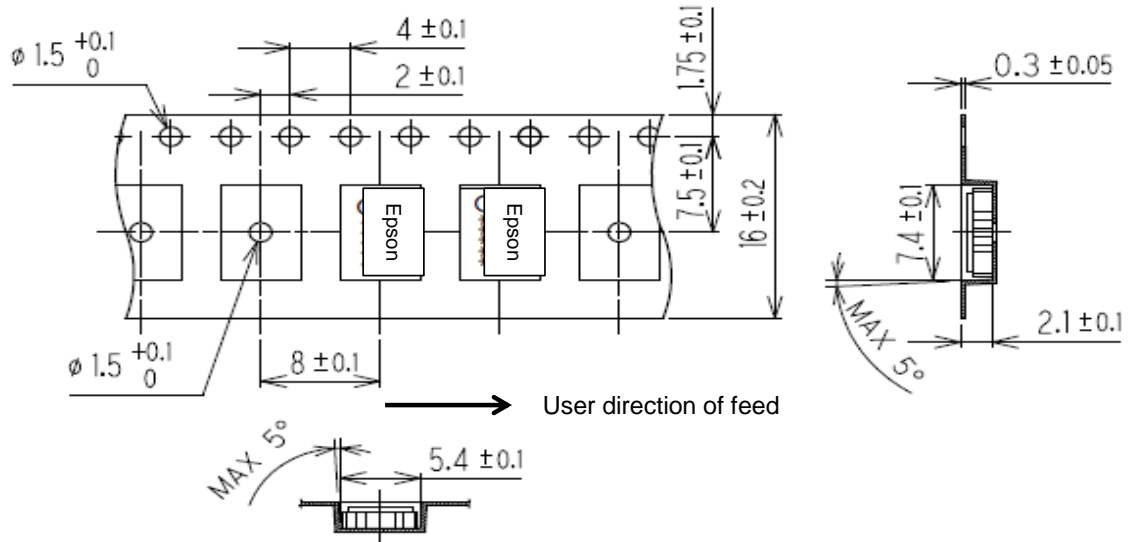

2) Reel Dimensions

Center Material: PS (Polystyrene)

Reel Material: PS (Polystyrene)

Units: mm

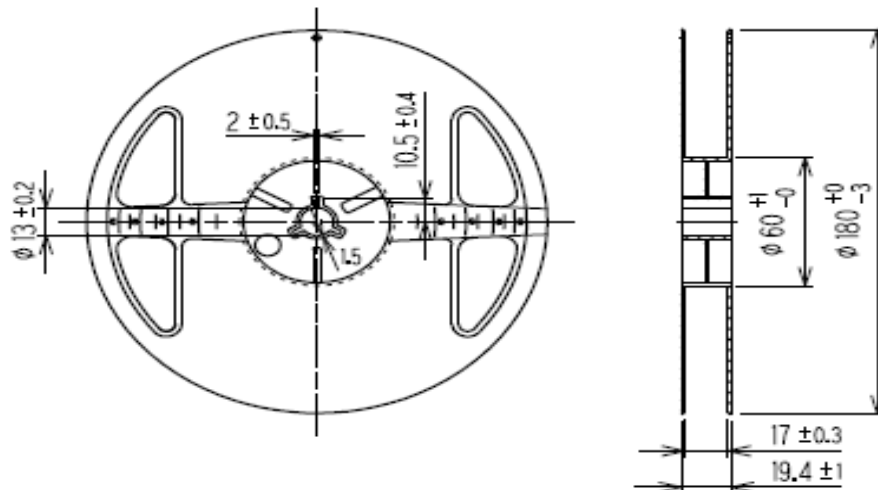

3) Storage Environment

We recommend to keep at normal temperature and normal humidity in a packed condition.

[13] Handling Precautions

Prior to using this product, please carefully read the section entitled "Precautions" on our Web site (<https://www5.epsondevice.com/en/information/#precaution>) for instructions on how to handle and use the product properly to ensure optimal performance of the product in your equipment.

Before using the product under any conditions other than those specified therein, please consult with us to verify and confirm that the performance of the product will not be negatively affected by use under such conditions.

In addition to the foregoing precautions, in order to avoid the deteriorating performance of the product, we strongly recommend that you DO NOT use the product under ANY of the following conditions:

- (1) Do not expose this product to excessive mechanical shock or vibration.
- (2) This product can be damaged by mechanical shock during the soldering process depending on the equipment used, process conditions, and any impact forces experienced. Always follow appropriate procedures, particularly when changing the assembly process in any way and be sure to follow applicable process qualification standards before starting production.
- (3) These devices are sensitive to ESD, use appropriate precautions during handling, assembly, test, shipment, and installation.
- (4) The use of ultrasonic technology for cleaning, bonding, etc. can damage the Xtal unit inside this product. Please carefully check for this consideration before using ultrasonic equipment for volume production with this product.
- (5) Noise and ripple on the power supply may have undesirable effects on operation and cause degradation of phase noise characteristics. Evaluate the operation of this device with appropriate power supplies carefully before use.
- (6) When applying power, ensure that the supply voltage increases monotonically for proper operation. On power down, do not reapply power until the supplies, bypass capacitors, and any bulk capacitors are completely discharged since that may cause the unit to malfunction.
- (7) Aging specifications are estimated from environmental reliability tests and expected frequency variation over time. They do not provide a guarantee of aging over the product lifecycle.
- (8) The metal cap on top of the device is directly connected to the GND terminal. Take necessary precautions to prevent any conductor not at ground potential from contacting the cap as that could cause a short circuit to GND.
- (9) Do not route any signal lines, supply voltage lines, or GND lines underneath the area where the oscillators are mounted including any internal layers and on the opposite side of the PCB. To avoid any issues due to interference of other signal lines, please take care not to place signal lines near the product as this may have an adverse effect on the performance of the product.
- (10) A bypass capacitor of the recommended value(s) must be connected between the V_{CC} and GND terminals of the product. Whenever possible, mount the capacitor(s) on the same side of the PCB and as close to the product as possible to keep the routing traces short.
- (11) Power supply connections to V_{CC} and GND pins should be routed as thick as possible while keeping the high frequency impedance low in order to get the best performance.
- (12) The use of a filter or similar element in series with the power supply connections to protect from electromagnetic radiation noise may increase the high frequency impedance of the power supply line and may cause the oscillator to not operate properly. Please verify the design to ensure sufficient operational margin prior to use.
- (13) Keep PCB routing from the output terminal(s) to the load as short as possible for best performance.
- (14) The Enable (OE) input terminal is high impedance and so susceptible to noise. Connect it to a low impedance source when used and when not used it is recommended to connect it to V_{CC} for active high inputs and GND for active low inputs.
- (15) Do not short the output to GND as that will damage the product. Always use with an appropriate load resistor connected.
- (16) This product should be reflowed no more than 3 times.
If rework is needed after reflow, please correct it with a soldering iron with the tip set for a temperature of +350 °C or less and only contact each terminal once and for no more than 5 seconds.
If this product is mounted on the bottom of the board during a reflow please check that it soldered down properly afterwards.
- (17) Product failures during the warranty period only apply when the product is used according to the recommended operating conditions described in the specifications. Products that have been opened for analysis or damaged will not be covered. It is recommended to store and use in normal temperature and humidity environments described in the specifications to ensure frequency accuracy and prevent moisture condensation. If the product is stored for more than one year, please confirm the pin solderability prior to use.
- (18) If the oscillation circuit is exposed to condensation, the frequency may change or oscillation may stop. Do not use in any conditions where condensation occurs.
- (19) Do not store or use the product in an environment where it can be exposed to chemical substances that are corrosive to metal or plastics such as salt water, organic solvents, chemical gasses, etc. Do not use the product when it is exposed to sunlight, dust, corrosive gasses, or other materials for long periods of time.
- (20) When using water-soluble solder flux make sure to completely remove the flux residue after soldering. Pay particular attention when the residues contain active halogens which will negatively affect the product and its performance.
- (21) Terminals on the side of the product are internally connected to the IC, be careful not to cause short-circuits or reduce the insulation resistance of them in any way.
- (22) Should any customer use the product in any manner contrary to the precautions and/or advice herein, such use shall be done at the customer's own risk.

[Availability of mounting conditions]

Reflow on the board	Available
Reflow under the board	The parts may fail. Please judge whether it is possible to implement.
Soldering pot/bath (Dip soldering system, Flow soldering system)	Not Available
Soldering iron	Available

PROMOTION OF ENVIRONMENTAL MANAGEMENT SYSTEM CONFORMING TO INTERNATIONAL STANDARDS

At Seiko Epson, all environmental initiatives operate under the Plan-Do-Check-Action (PDCA) cycle designed to achieve continuous improvements. The environmental management system (EMS) operates under the ISO 14001 environmental management standard.

All of our major manufacturing and non-manufacturing sites, in Japan and overseas, completed the acquisition of ISO 14001 certification.



ISO 14000 is an international standard for environmental management that was established by the International Standards Organization in 1996 against the background of growing concern regarding global warming, destruction of the ozone layer, and global deforestation.

WORKING FOR HIGH QUALITY

In order provide high quality and reliable products and services than meet customer needs, Seiko Epson made early efforts towards obtaining ISO9000 series certification and has acquired ISO9001 for all business establishments in Japan and abroad. We have also acquired IATF 16949 certification that is requested strongly by major manufacturers as standard.

IATF 16949 is the international standard that added the sector-specific supplemental requirements for automotive industry based on ISO9001.

■ Explanation of marks used in this datasheet

	<p>● Pb free.</p>
	<p>● Complies with EU RoHS directive. *About the products without the Pb-free mark. Contains Pb in products exempted by EU RoHS directive (Contains Pb in sealing glass, high melting temperature type solder or other)</p>

NOTICE: PLEASE READ CAREFULLY BELOW BEFORE THE USE OF THIS DOCUMENT ©Seiko Epson Corporation 2020

- The content of this document is subject to change without notice. Before purchasing or using Epson products, please contact with sales representative of Seiko Epson Corporation ("Epson") for the latest information and be always sure to check the latest information published on Epson's official web sites and resources.
- This document may not be copied, reproduced, or used for any other purposes, in whole or in part, without Epson's prior consent.
- Information provided in this document including, but not limited to application circuits, programs and usage, is for reference purpose only. Epson makes no guarantees against any infringements or damages to any third parties' intellectual property rights or any other rights resulting from the information. This document does not grant you any licenses, any intellectual property rights or any other rights with respect to Epson products owned by Epson or any third parties.
- Using Epson products, you shall be responsible for safe design in your products; that is, your hardware, software, and/or systems shall be designed enough to prevent any critical harm or damages to life, health or property, even if any malfunction or failure might be caused by Epson products. In designing your products with Epson products, please be sure to check and comply with the latest information regarding Epson products (including, but not limited to this document, specifications, data sheets, manuals, and Epson's web site). Using technical contents such as product data, graphic and chart, and technical information, including programs, algorithms and application circuit examples under this document, you shall evaluate your products thoroughly both in stand-alone basis and within your overall systems. You shall be solely responsible for deciding whether to adopt/use Epson products with your products.
- Epson has prepared this document carefully to be accurate and dependable, but Epson does not guarantee that the information is always accurate and complete. Epson assumes no responsibility for any damages you incurred due to any misinformation in this document.
- No dismantling, analysis, reverse engineering, modification, alteration, adaptation, reproduction, etc., of Epson products is allowed.
- Epson products have been designed, developed and manufactured to be used in general electronic applications and specifically requires particular quality or extremely high reliability in order to refrain from causing any malfunction or failure leading to critical harm to life and health, serious property damage, or severe impact on society, including, but not limited to listed below ("Specific Purpose"). Therefore, you are strongly advised to use Epson products only for the Anticipated Purpose. Should you desire to purchase and use Epson products for Specific Purpose, Epson makes no warranty and disclaims with respect to Epson products, whether express or implied, including without limitation any implied warranty of merchantability or fitness for any Specific Purpose. Please be sure to contact our sales representative in advance, if you desire Epson products for Specific Purpose:
 Space equipment (artificial satellites, rockets, etc.)/ Transportation vehicles and their control equipment (automobiles, aircraft, trains, ships, etc.) / Medical equipment/ Relay equipment to be placed on sea floor/ Power station control equipment / Disaster or crime prevention equipment/Traffic control equipment/ Financial equipment
 Other applications requiring similar levels of reliability as the above
- Epson products listed in this document and our associated technologies shall not be used in any equipment or systems that laws and regulations in Japan or any other countries prohibit to manufacture, use or sell. Furthermore, Epson products and our associated technologies shall not be used for the purposes of military weapons development (e.g. mass destruction weapons), military use, or any other military applications. If exporting Epson products or our associated technologies, please be sure to comply with the Foreign Exchange and Foreign Trade Control Act in Japan, Export Administration Regulations in the U.S.A (EAR) and other export-related laws and regulations in Japan and any other countries and to follow their required procedures.
- Epson assumes no responsibility for any damages (whether direct or indirect) caused by or in relation with your non-compliance with the terms and conditions in this document or for any damages (whether direct or indirect) incurred by any third party that you give, transfer or assign Epson products.
- For more details or other concerns about this document, please contact our sales representative.
- Company names and product names listed in this document are trademarks or registered trademarks of their respective companies.