

**MJD42C** TRANSISTOR (PNP)

**FEATURES**

- Designed for General Purpose Amplifier and Low Speed Switching Applications.
- Lead Formed for Surface Mount Applications in Plastic Sleeves (No Suffix)
- Straight Lead Version in Plastic Sleeves (“-1” Suffix)
- Lead Formed Version in 16 mm Tape and Reel (“T4” Suffix)
- Electrically Similar to Popular TIP41 and TIP42 Series
- Monolithic Construction With Built-in Base-Emitter Resistors

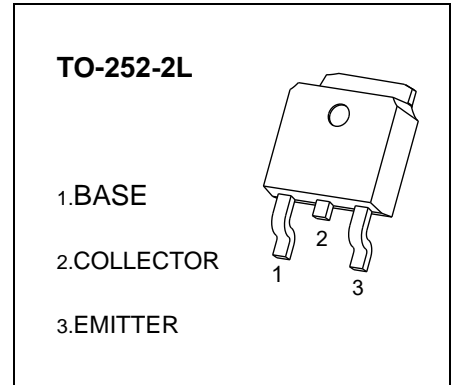

**MARKING**

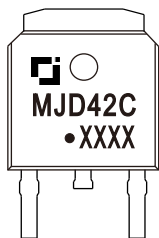

MJD42C=Device code  
Solid dot=Green moldinn compound device,  
if none,the normal device  
XXXX=Code

**Equivalent Circuit**

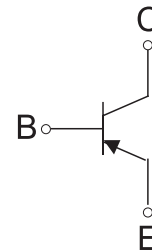

**MAXIMUM RATINGS (Ta=25°C unless otherwise noted)**

Symbol	Parameter	Value	Unit
V <sub>CB0</sub>	Collector-Base Voltage	-100	V
V <sub>CEO</sub>	Collector-Emitter Voltage	-100	V
V <sub>EBO</sub>	Emitter-Base Voltage	-5	V
I <sub>C</sub>	Collector Current -Continuous	-6	A
I <sub>CP</sub> *	Collector Current -Pluse	-10	A
P <sub>C</sub>	Collector Power Dissipation	1.25	W
R <sub>θJC</sub> ①	Thermal Resistance from Junction to Case	5.0	°C W
R <sub>θJA</sub> ②	Thermal Resistance from Junction to Ambient	100	°C W
T <sub>J</sub> ,T <sub>stg</sub>	Operating Junction and Storage Temperature Range	-55-150	°C

# MOSFET ELECTRICAL CHARACTERISTICS

## ELECTRICAL CHARACTERISTICS (T<sub>a</sub>=25°C unless otherwise specified)

Parameter	Symbol	Test conditions	Min	Typ	Max	Unit
Collector-base breakdown voltage	V <sub>(BR)CBO</sub>	I <sub>C</sub> =-100μA, I <sub>E</sub> =0	-100			V
Collector-emitter breakdown voltage	V <sub>CEO(sus)</sub>	I <sub>C</sub> =-30mA, I <sub>B</sub> =0	-100			V
Emitter-base breakdown voltage	V <sub>(BR)EBO</sub>	I <sub>E</sub> =-100μA, I <sub>C</sub> =0	-5			V
Collector cut-off current	I <sub>CEO</sub>	V <sub>CE</sub> =-60V, I <sub>E</sub> =0			-50	μA
Emitter cut-off current	I <sub>EBO</sub>	V <sub>EB</sub> =-5V, I <sub>C</sub> =0			-0.5	mA
DC current gain	h <sub>FE(1)</sub>	V <sub>CE</sub> =-4V, I <sub>C</sub> =-0.3A	30			
	h <sub>FE(2)</sub>	V <sub>CE</sub> =-4V, I <sub>C</sub> =-3A	15		75	
Collector-emitter saturation voltage	V <sub>CE(sat)</sub>	I <sub>C</sub> =-6A, I <sub>B</sub> =-0.6A			-1.5	V
Base-emitter voltage	V <sub>BE</sub>	V <sub>CE</sub> =-4V, I <sub>C</sub> =-6A			-2	V
Transition frequency	f <sub>T</sub>	V <sub>CE</sub> =-10V, I <sub>C</sub> =-500mA, f=1MHz	3			MHz

\* Pulse Test: PW≤300μs, Duty Cycle≤2%

Notes:

1. T<sub>C</sub> 25 °C.

2. Device mounted on 1 in<sup>2</sup> FR-4 board with 2oz single-sided Copper, in a still air environment with T<sub>A</sub> 25°C.

# Typical Characteristics

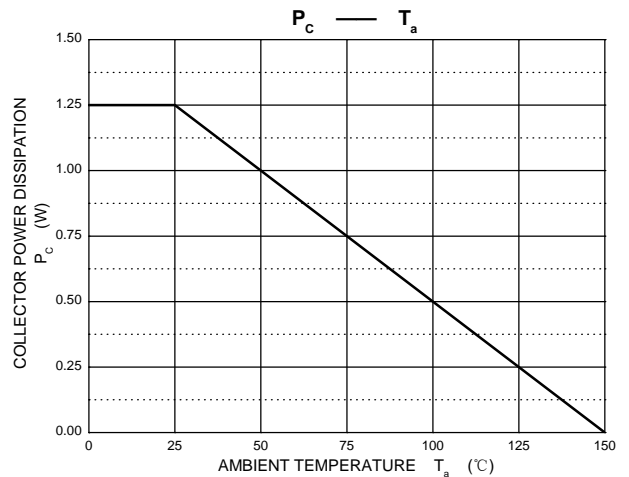
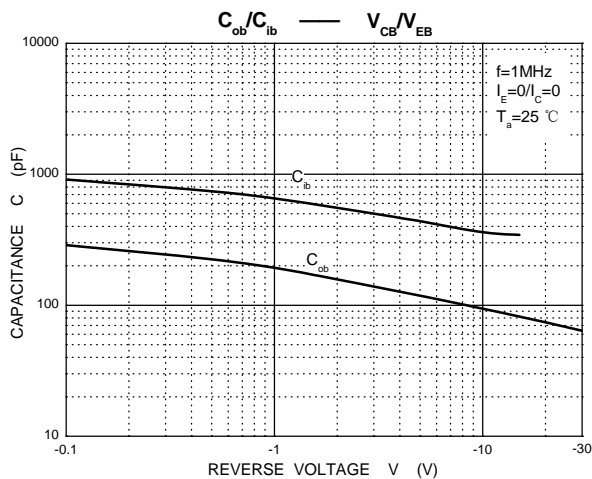
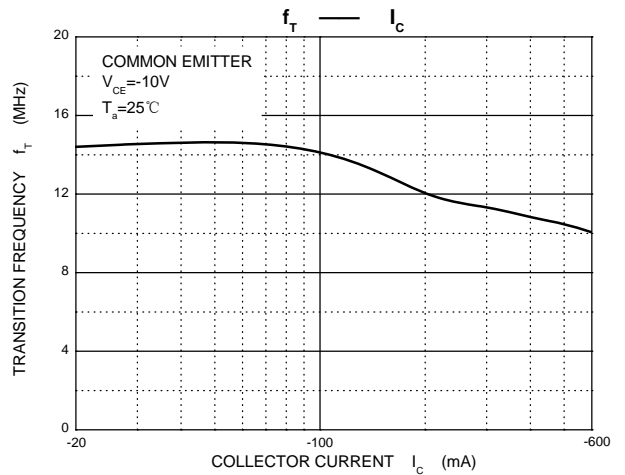
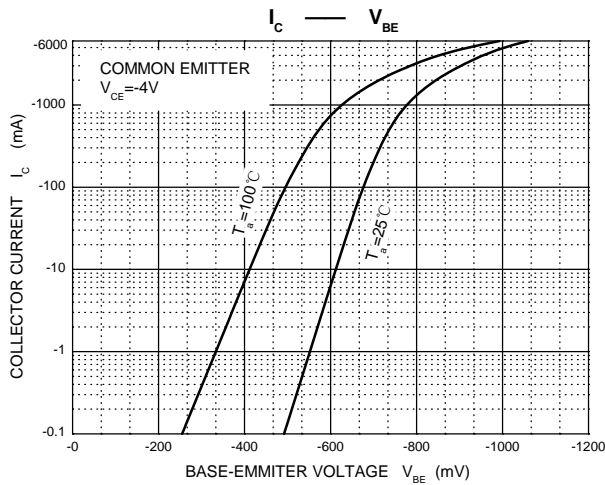
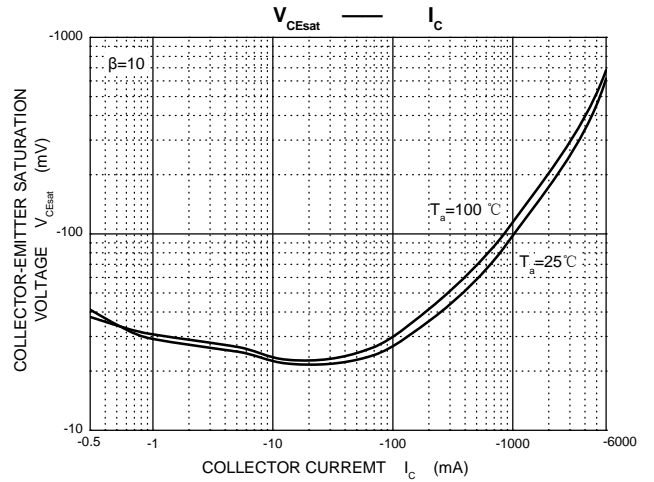
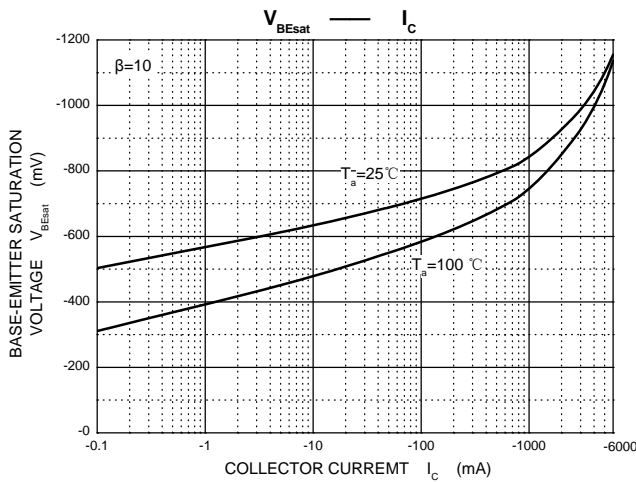
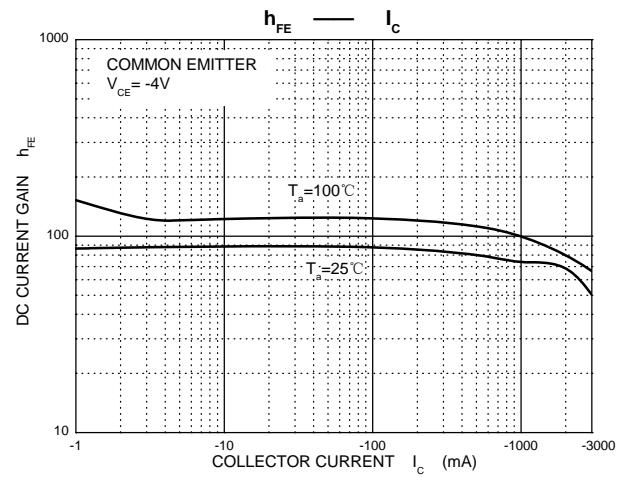
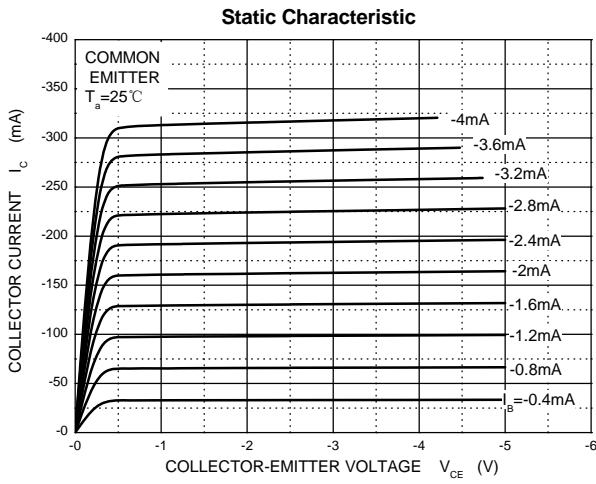

# Typical Characteristics

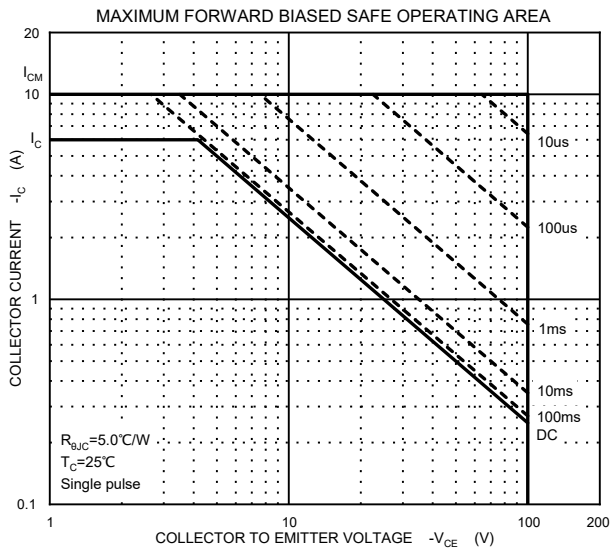
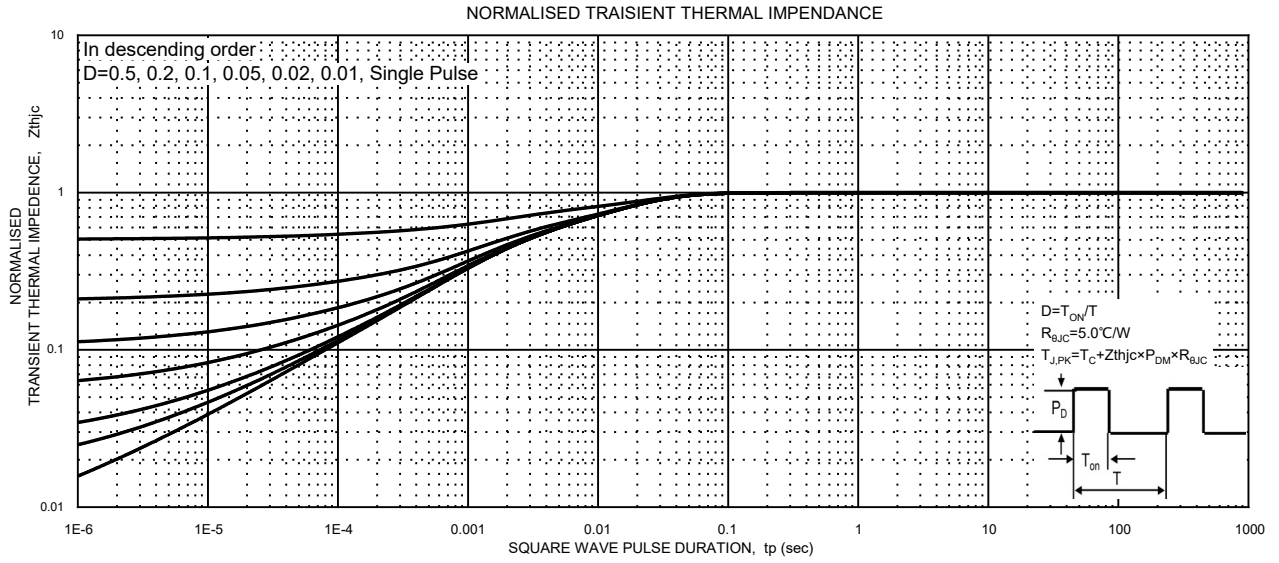

## TO-252-2L Package Outline Dimensions

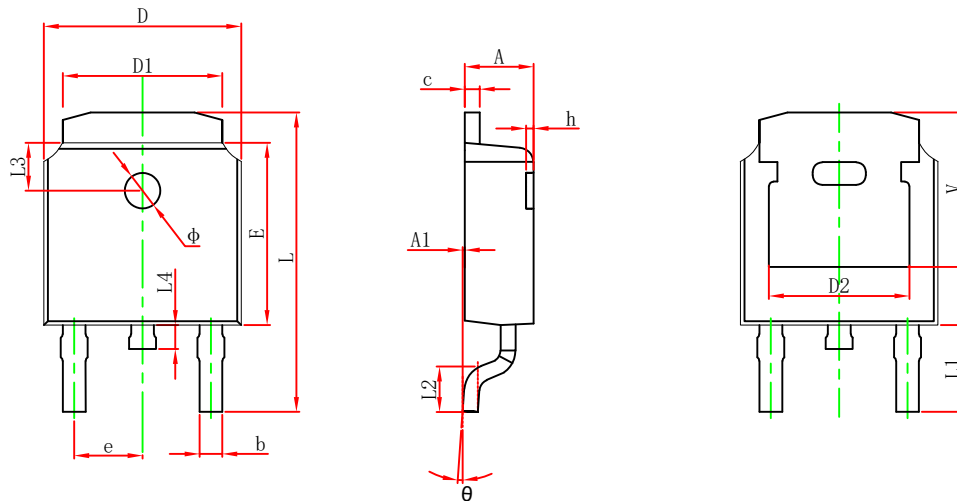

Symbol	Dimensions In Millimeters		Dimensions In Inches	
	Min.	Max.	Min.	Max.
A	2.200	2.400	0.087	0.094
A1	0.000	0.127	0.000	0.005
b	0.635	0.770	0.025	0.030
c	0.460	0.580	0.018	0.023
D	6.500	6.700	0.256	0.264
D1	5.100	5.460	0.201	0.215
D2	4.830 REF.		0.190 REF.	
E	6.000	6.200	0.236	0.244
e	2.186	2.386	0.086	0.094
L	9.712	10.312	0.382	0.406
L1	2.900 REF.		0.114 REF.	
L2	1.400	1.700	0.055	0.067
L3	1.600 REF.		0.063 REF.	
L4	0.600	1.000	0.024	0.039
$\Phi$	1.100	1.300	0.043	0.051
$\theta$	0°	8°	0°	8°
h	0.000	0.300	0.000	0.012
V	5.250 REF.		0.207 REF.	

## TO-252-2L Suggested Pad Layout

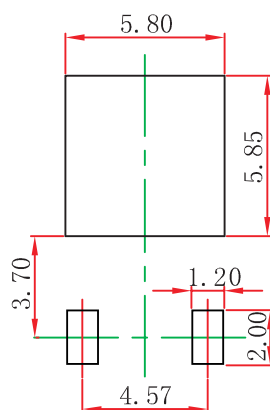

- Note:
1. Controlling dimension: in millimeters.
  2. General tolerance:  $\pm 0.05$  mm.
  3. The pad layout is for reference purposes only.

### NOTICE

JSCJ reserves the right to make modifications, enhancements, improvements, corrections or other changes without further notice to any product herein. JSCJ does not assume any liability arising out of the application or use of any product described herein.

# TO-252-2L Tape and Reel

## TO-252 Embossed Carrier Tape

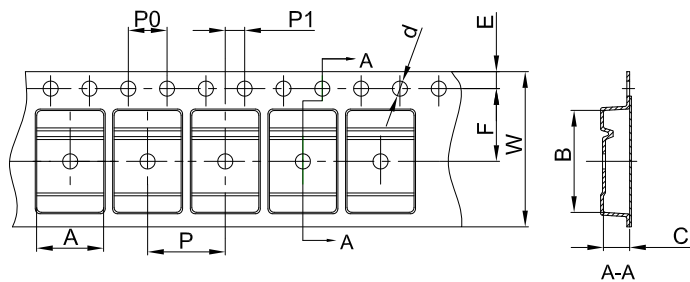

### Packaging Description:

TO-252 parts are shipped in tape. The carrier tape is made from a dissipative (carbon filled) polycarbonate resin. The cover tape is a multilayer film (Heat Activated Adhesive in nature) primarily composed of polyester film, adhesive layer, sealant, and anti-static sprayed agent. These reeled parts in standard option are shipped with 25,00 units per 13" or 33.0 cm diameter reel. The reels are clear in color and is made of polystyrene plastic (anti-static coated).

Dimensions are in millimeter										
Pkg type	A	B	C	d	E	F	P0	P	P1	W
TO-252	6.90	10.50	2.70	Ø1.55	1.75	7.50	4.00	8.00	2.00	16.00

## TO-252 Tape Leader and Trailer

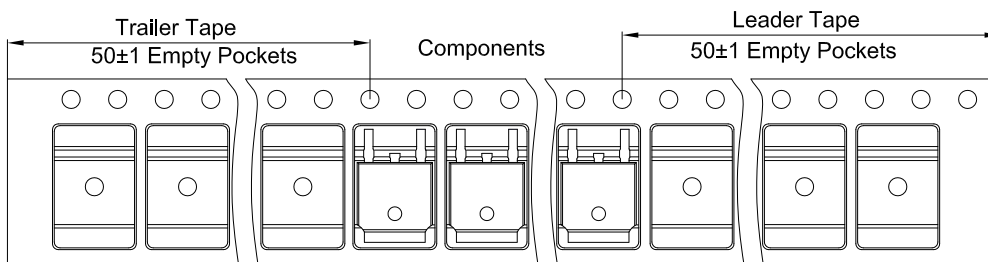

## TO-252 Reel

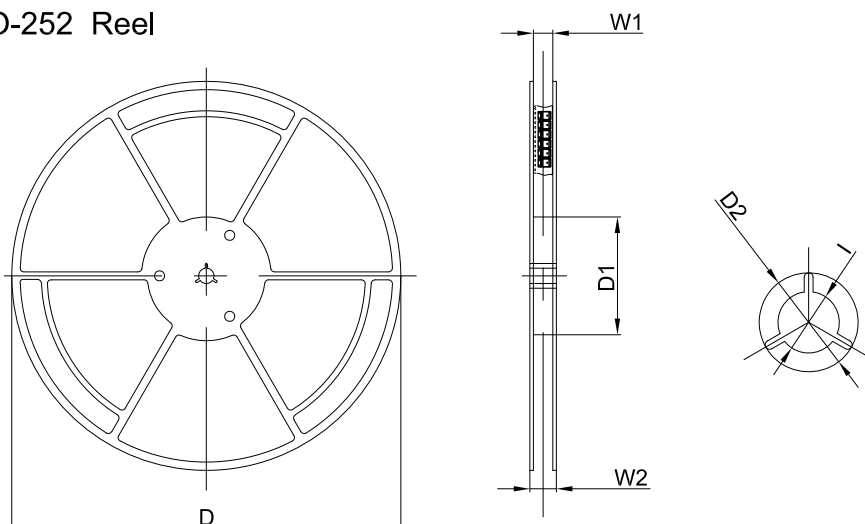

Dimensions are in millimeter						
Reel Option	D	D1	D2	W1	W2	I
13" Dia	330.00	100.00	Ø21.00	16.40	21.00	Ø13.00

REEL	Reel Size	Box	Box Size(mm)	Carton	Carton Size(mm)	G.W.(kg)
2,500 pcs	13inch	2,500 pcs	340×336×29	25,000 pcs	353×346×365	